

GO WITH  
THE NATION'S  
FAVOURITE



Caravans 2023





## Welcome to Bailey, The Nation's Favourite.

We've been proudly hitting the road for over 70 years. Along the way, we've built hundreds of thousands of Bailey caravans and motorhomes, each of them made with one thing in mind: creating the perfect holiday.

So, no matter which of our models you choose for your home away from home; comfort, convenience and adventure are built into every one.

**GO BAILEY!** We can't wait to see you out there.



### Contents

Bailey heritage	02
Build quality	04
Value standards	06
Made in Bristol	08
Tested to the limit	10
Choose your layout	12
Choose your Bailey	14
RANGES	
Alicanto Grande	18
Pegasus Grande SE	30
Unicorn	42
Phoenix+	54
Discovery	64
PRIMA accessories	76
Where to buy	78
Bailey Owners Club	79

## Bailey by name...

The Bailey story started back in 1948, when Martin Bailey designed and built the very first Bailey caravan in his South Bristol garage. His caravans soon captured the nation's growing quest for adventure, and Bailey quickly grew into the thriving, family-run business it still is today.

We've come a long way since those early days, but even with 75 years of experience now behind us we have never stopped considering how we can push the boundaries in everything we do to make us a better business. And, like you, we're always looking forward to our next adventure, of course...

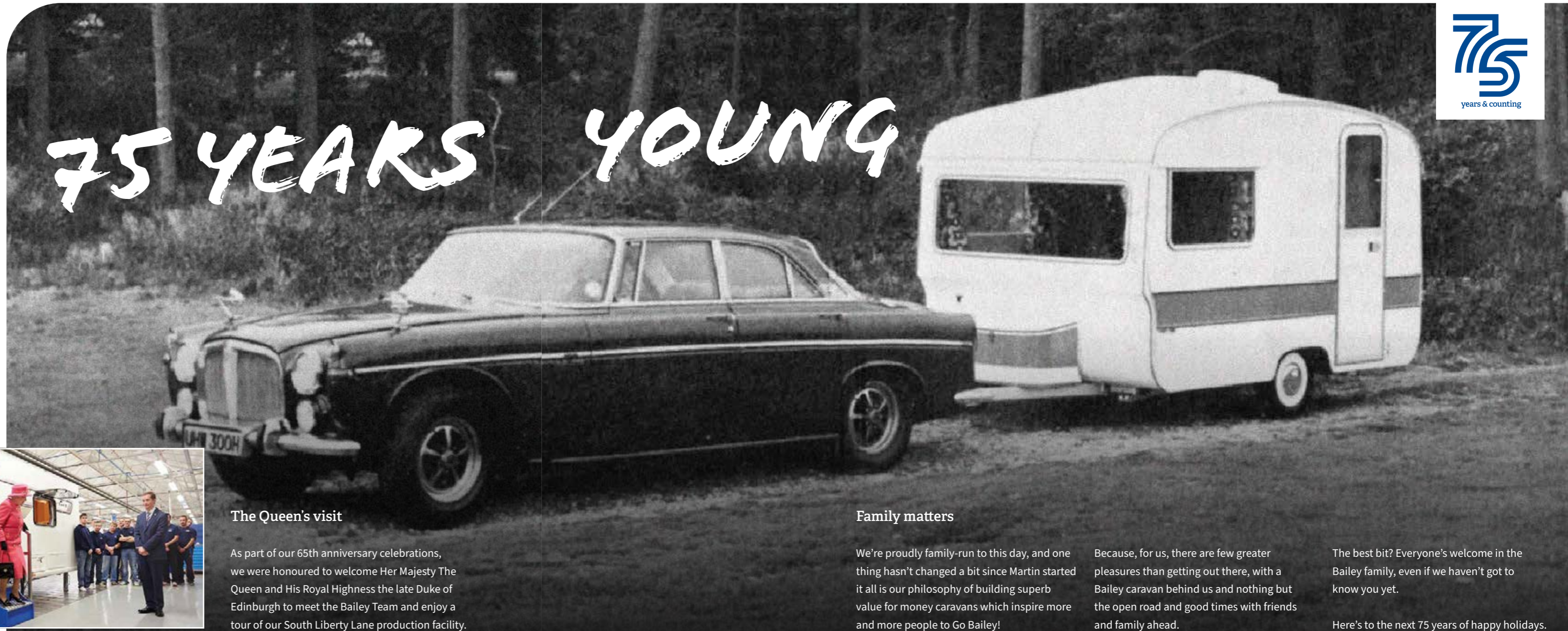

### The Queen's visit

As part of our 65th anniversary celebrations, we were honoured to welcome Her Majesty The Queen and His Royal Highness the late Duke of Edinburgh to meet the Bailey Team and enjoy a tour of our South Liberty Lane production facility.

### Family matters

We're proudly family-run to this day, and one thing hasn't changed a bit since Martin started it all is our philosophy of building superb value for money caravans which inspire more and more people to Go Bailey!

Because, for us, there are few greater pleasures than getting out there, with a Bailey caravan behind us and nothing but the open road and good times with friends and family ahead.

The best bit? Everyone's welcome in the Bailey family, even if we haven't got to know you yet.

Here's to the next 75 years of happy holidays.

# What goes into The Nation's Favourite?

It all started with a simple question: "Is there a better way?" Leisure vehicle design and construction hadn't moved on very much for over 30 years, until we developed Alu-Tech and changed everything.

Alu-Tech is a completely new approach to bodysell construction. Using a unique interlocking aluminium framework to clamp the body panels together, Bailey created a shell that was so much more robust and durable than anything else.

Greater protection against the elements comes from a significant reduction in the number of external joints and fixing points, along with using timber-free components in the upper bodysell panels. Thicker, better-insulated panels, cloaked in impact resistant GRP (Glass Reinforced Plastic), hugely improve the thermal performance of the bodysell, for genuine four-season performance. All this, with no increase in weight or cost.

Turns out, there is a better way.

\*Terms and conditions apply.  
Please visit [baileyofofbristol.co.uk/warranties-servicing](http://baileyofofbristol.co.uk/warranties-servicing) for more information.

Since Alu-Tech first hit the road ten years ago, we've built more than 75,000 leisure vehicles using Alu-Tech technology.

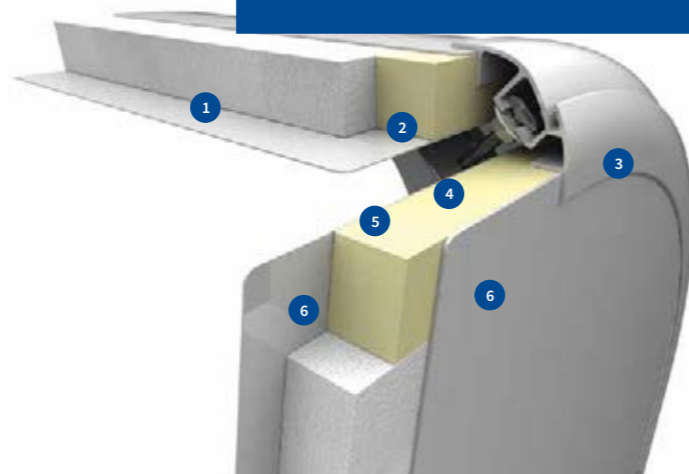

- 1 Polystyrene core
- 2 Composite plastic extrusion
- 3 Alu-Tech rail
- 4 Structural fixing bracket
- 5 Alu-Tech rail insulation
- 6 GRP (Glass Reinforced Plastic) outer and inner skin



**3 year**  
transferable manufacturer's components warranty\*

**6 year**  
transferable bodysell integrity warranty\*  
Access to aftercare team

**LIGHTWEIGHT DESIGN**  
Alu-Tech is 10% lighter than conventional construction methods making them accessible to a wider range of tow vehicles.

**TIMBER-FREE PANEL CONSTRUCTION**  
Timber-free bodysell panels are more resistant to the elements, enhancing their longevity.

**CENTRALLY MOUNTED GAS LOCKER AND BATTERY BOX**  
Improved weight distribution enhances vehicle stability and reduces nose weights.

**AL-KO CHASSIS AND STABILISER HITCH**  
Provides the best possible platform on which to build our caravans, by maximising on-the-road stability.

**SUPERIOR THERMAL INSULATION**  
Thicker fully laminated bodypanels provide superior thermal performance that allows you to holiday all year around.

**BODYSHELL CONSTRUCTION**  
Four/five part fully laminated bodysell construction enhances strength.



**INTERLOCKING ALUMINIUM FRAMEWORK**  
Internal fixings clamp the body panels together, producing a shell of unrivalled strength and rigidity.

**PRE-WIRED FOR WIFI**  
Pre-wired for easy retailer fit of mobile WiFi system.

**AERO-DYNAMIC PROFILE**  
Curved rear domes optimise air flow to improve safety and fuel economy.

**MORE INTERIOR SPACE**  
Flat roof panel design creates more internal headroom (1.96m or 6'5").

**GRP CLOAKED BODY SHELL**  
Glass reinforced plastic skin for greater impact resistance and superior thermal insulation.

**MOTORMOVER FITMENT**  
Pre-wired at the factory for the fitment of an optional motormover by your Retailer (cost option).

**SUPER-SAFE WHEEL ASSEMBLIES**  
Pre-balanced TUV tested alloy wheels and bespoke caravan tyres.

**EVEN MORE INTERIOR SPACE**  
Single skin front and rear panels increase overall internal body lengths, allowing for longer front seats and fixed beds, and larger shower cubicles.

## We believe in more

We build every Bailey caravan on one simple principle: with high specifications at superb value for money with no hidden extras.

Simply put, we believe in more – and know that it's the little things that go a long way. Comfort and convenience come as standard in every Bailey, but you'll also find a host of extra features to make you feel at home, wherever you choose to make it.

So it's not just your money that goes further. Our signature build quality means you and your Bailey do too.



...JUST ADD FUN

**EUROPEAN COMMUNITY WHOLE VEHICLE TYPE APPROVAL (ECWVTA)**  
All our caravans meet stringent European environmental, safety and security standards.

**BRITISH HEALTH AND SAFETY**  
All our caravans comply with British Health and Safety legislation, as certified by the National Caravan Council.

**SUPERIOR THERMAL PERFORMANCE**  
The highest classification of thermal insulation (Grade III of EN1645-I) makes all our caravans four-season certified.

**SAFE AND SECURE**  
CRIS vehicle recognition system, concealed security data chip, plus smoke and carbon monoxide alarms.

**FRONT VERTICAL SKYLIGHT**  
Our signature front vertical skylight provides unbroken views and fills the living area with natural light.

**WINDOW BLINDS**  
Protection and privacy on all windows and rooflights, as well as the main entrance door.

**USB SOCKETS**  
Conveniently located USBs throughout.

**TV AERIAL AND STATION**  
Keep up to date with your favourite TV programmes courtesy of the Status 570 digital directional aerial.

**MARKET-LEADING HEATING SYSTEMS**  
Fitment of either Truma or Alde heating systems keeps you comfortable whatever the weather.

**INTERNAL LIGHTING SYSTEMS**  
12v interior LED task and mood lighting systems, with down-lighters and directional spotlights.

**FURNISHINGS AND FLOORS**  
Premium quality fabrics and superior cushion construction, with practical drop in carpets (range specific) over durable floor vinyl.

**DOMETIC REFRIGERATORS**  
Spacious Dometic refrigerators give you extra space for keeping your food and drink fresh.

**THETFORD COOKING APPLIANCES**  
Rustle up your favourites with premium Thetford appliances featuring an oven, grill and hob.

**BAILEY VALUE**  
As the Nation's Favourite we like to give you more – meaning more standard specifications for your money and less on the optional extras list.

## Made in Bristol

We've been proud to call South Bristol home since 1948. Martin Bailey designed and built the first Bailey caravan in his garage, just a stone's throw from the South Liberty Lane site that now houses our 14.5-acre production facility.

We think of ourselves as one big family. Most of us live nearby and have been part of Bailey for a long time (ten years is the average length of service).

### Over 500 hands make every Bailey

From our joiners and electricians, to our designers and fabricators, we have the skills, expertise and experience to build a complex range of caravans and motorhomes, all in the same plant – and all by hand.

We've invested heavily in South Liberty Lane over the last 20 years, including the UK's only mechanised assembly line, so our optimised production process is considered one of the most advanced in Europe. Quantity sits very comfortably with quality.



OVER 500 HANDS  
HELP MAKE  
EVERY BAILEY

## The road ahead

To push UK leisure vehicle manufacturing to the next level, we've completely redeveloped our South Liberty Lane site.

By relocating PRIMA Leisure to North Bristol and our Large Panel Laminating Plant (which makes caravan sides, ceilings and floors) to North Somerset, we've made space for the purpose-built Replenishment Centre, where we can store the thousands of parts we need to build our caravans and motorhomes. So the future of Bailey is as exciting and innovative as its past.



## Tested to the limit

From desert dust to Arctic ice, we put our caravans through their paces, so they're at their best on the roads of Great Britain – and beyond.

Good enough simply isn't good enough. It's why we go to such great – and sometimes extreme – lengths to make sure our caravans and motorhomes can perform, whatever's thrown their way.

It's only through rigorous testing that we're satisfied our products are ready for the road. It's why we push our vehicles harder and further, and for longer – and continually set industry performance standards.

Every new range, for example, goes through cold chamber testing down to -15°C, so we can work with our heating system partners, to get the best possible results in thermal insulation classification. We also put them through accelerated life tests, so we can complete a full structural evaluation. The test conditions are far in excess of what a caravan is likely to encounter in its lifetime.

If something's not up to the job, we go back to the drawing board until it is, before testing it rigorously to make sure it's right. That way, when our products get out there on the road, we know every single one is the best it can be.



 Watch our testing videos online [Go to baileyofbristol.co.uk/tested-to-the-limit](http://Go to baileyofbristol.co.uk/tested-to-the-limit)

## Go anywhere, do everything

Cold chambers and test trucks are one thing, but few things beat getting out there properly.

In 2015, we took two caravans on a 3,500-mile journey through the Australian Outback. During the two-week trip, they stood up to everything the elements could throw at them, proving they could hold their own in even the toughest conditions.

In 2017, we embarked on another marathon endurance test; this time with two caravans and a motorhome, on a 5,000-mile trip to Northern Finland – and well inside the Arctic Circle. Conditions couldn't have been more different than the Red Centre of Australia, but once again the vehicles took everything in their stride.

The successes of these adventures really whet our appetite. So, we decided to embark on a third: 21 countries in 21 days, across two continents – without a rest. From Bristol to Istanbul, we're proud to say the vehicles were more than capable and eager for more – even if we were well in need of a break.



# Choose your layout

Before you explore which range and model is right for you, you can narrow down your choice by berth, bed configuration and washroom placement. You'll see which ranges correspond to your choices in the coloured bars beneath each layout.



## 8ft wide touring caravans

Extra space that's made for touring or seasonal use, and available across the Alicanto Grande and Pegasus Grande SE ranges.

2↑

Front lounge  
End washroom

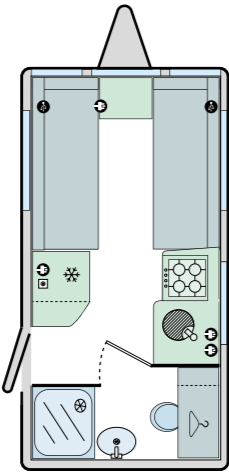

4↑

Side dinette  
End washroom

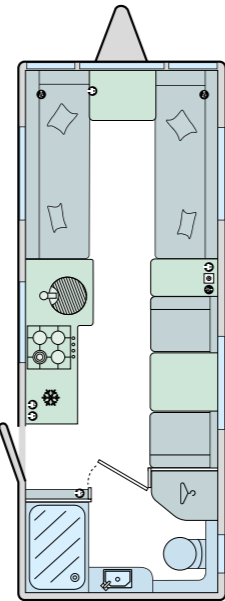

4↑

Corner double bed  
End washroom

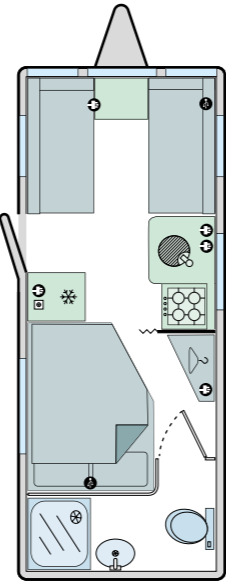

4↑

Twin bed  
End washroom

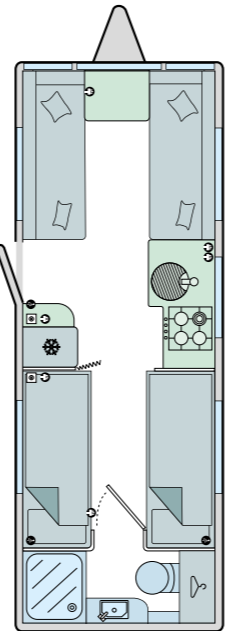

4↑

Island double bed  
Central washroom

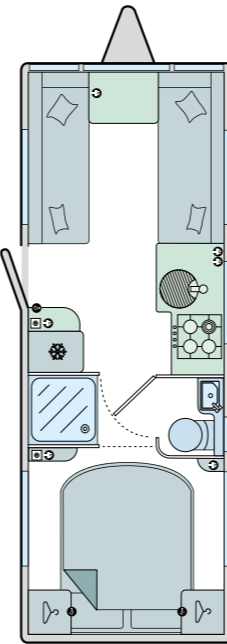

4↑

Island double bed  
End washroom

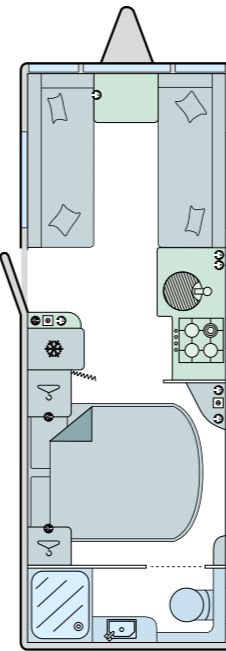

5↑

Bunk bed  
End washroom

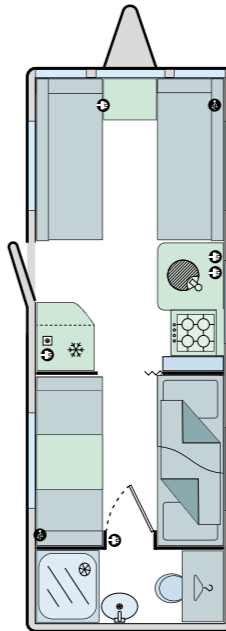

3↑ 5↑

Twin lounge  
Mid washroom

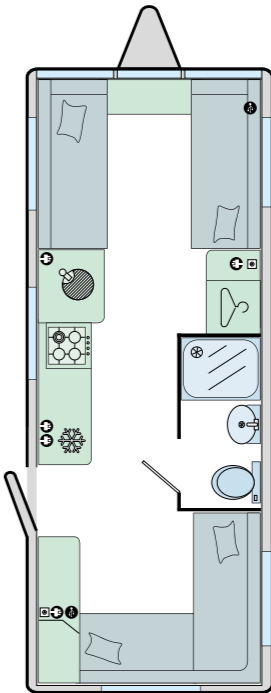

6↑

Corner double bed  
Corner washroom

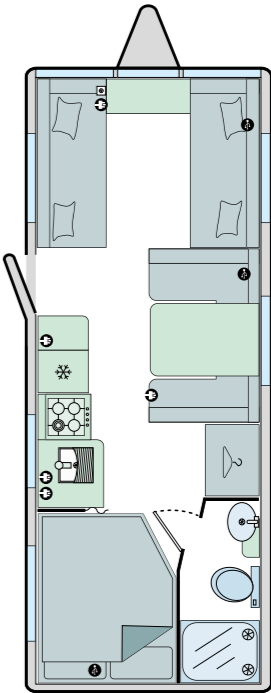

6↑

Bunk bed  
Corner washroom

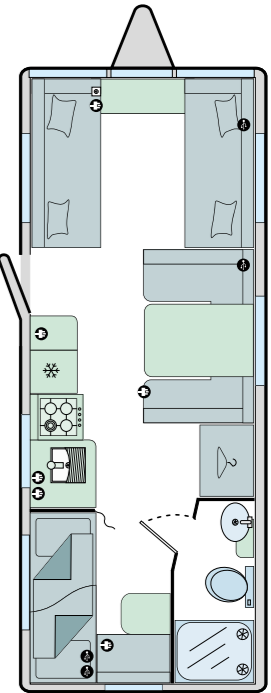

Layouts available in the following ranges:

Single axle options

Twin axle options

Unicorn p.42  
Phoenix+ p.54  
Discovery p.64

Unicorn p.42

Phoenix+ p.54  
Discovery p.64

Pegasus G-SE p.30 8ft  
Unicorn p.42  
Phoenix+ p.54

Alicanto Grande p.18 8ft  
Pegasus G-SE p.30 8ft  
Unicorn p.42  
Phoenix+ p.54

Alicanto Grande p.18 8ft  
Pegasus G-SE p.30 8ft  
Unicorn p.42  
Phoenix+ p.54

Phoenix+ p.54

Discovery p.64  
Pegasus G-SE p.30 8ft

Pegasus G-SE p.30 8ft

Pegasus G-SE p.30 8ft

Find your perfect Bailey online Go to [baileyofbristol.co.uk/compare-caravans](http://baileyofbristol.co.uk/compare-caravans)





Introducing  
Bailey caravans

...HERE WE GO

 Find your perfect Bailey online    Go to [baileyofbristol.co.uk/compare-caravans](http://baileyofbristol.co.uk/compare-caravans)



# ALICANTO GRANDE

NEW

Luxurious & limitless



# FIVE-STAR ADVENTURE

8ft  
WIDE

## Get to know Alicanto Grande

Generous in every direction, the 8ft wide Alicanto Grande is the last word in luxury. Choose from three fully specified layouts, where the only thing not included is the view.

3 Models

4 Berths

### Favourite facts

- Vertical infinity front window – with a 50% increase on window size
- AL-KO ATC trailer control system and stabiliser hitch
- Four season all weather sustainability with Alde radiator central heating system
- Tech ready with Avtex mobile WiFi and wireless charging pad
- 5ft wide king-size fixed island beds with superior pocket sprung 'Poise' mattress

Packed to the rooflights with features, the Alicanto Grande is our flagship range, where comfort, style and practicality combine to take luxury to a whole new level.

At 8ft wide, there's an extra 10% of floor space, to give you enhanced seating and king-size fixed beds, complete with pocket sprung 'Poise' mattresses. You'll find smart use of space throughout, along with the latest appliances, technology and safety features – all in a package that's as comfortable touring as it is for seasonal use. Wherever you decide to take the Alicanto Grande, you'll turn heads.



Model | Lisbon

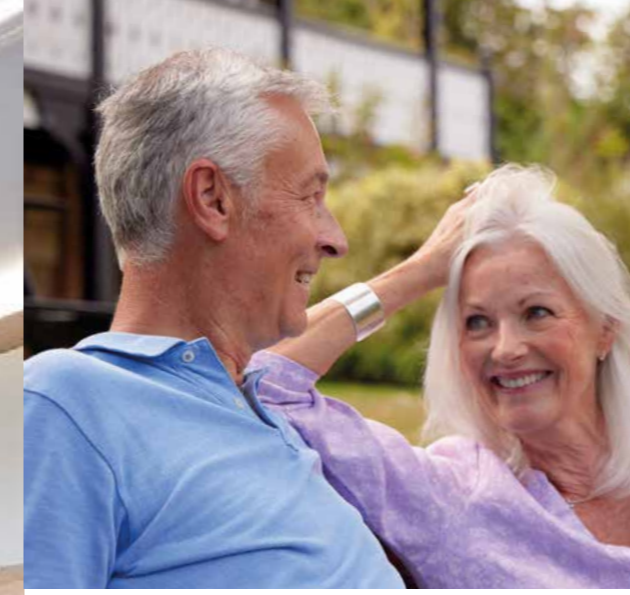

### Key features

- 1 Vertical infinity front window and moulded surround with integral task lighting and speakers
- 2 Dual finish 'Satin Cashmere' British design overhead curved locker doors with 'Light Oak' contrasting stripe
- 3 **New** streamline front corner lockers
- 4 **New** optional 'Latimer' soft furnishings with practical Aquaclean fabric
- 5 Conventional cushion construction with fully sprung knee rolled base cushions, foam filled back rests and curved corner sections with removable head rests
- 6 L-shape kitchen design
- 7 **New** 'Hazelnut' deep pile loose fit drop in carpets

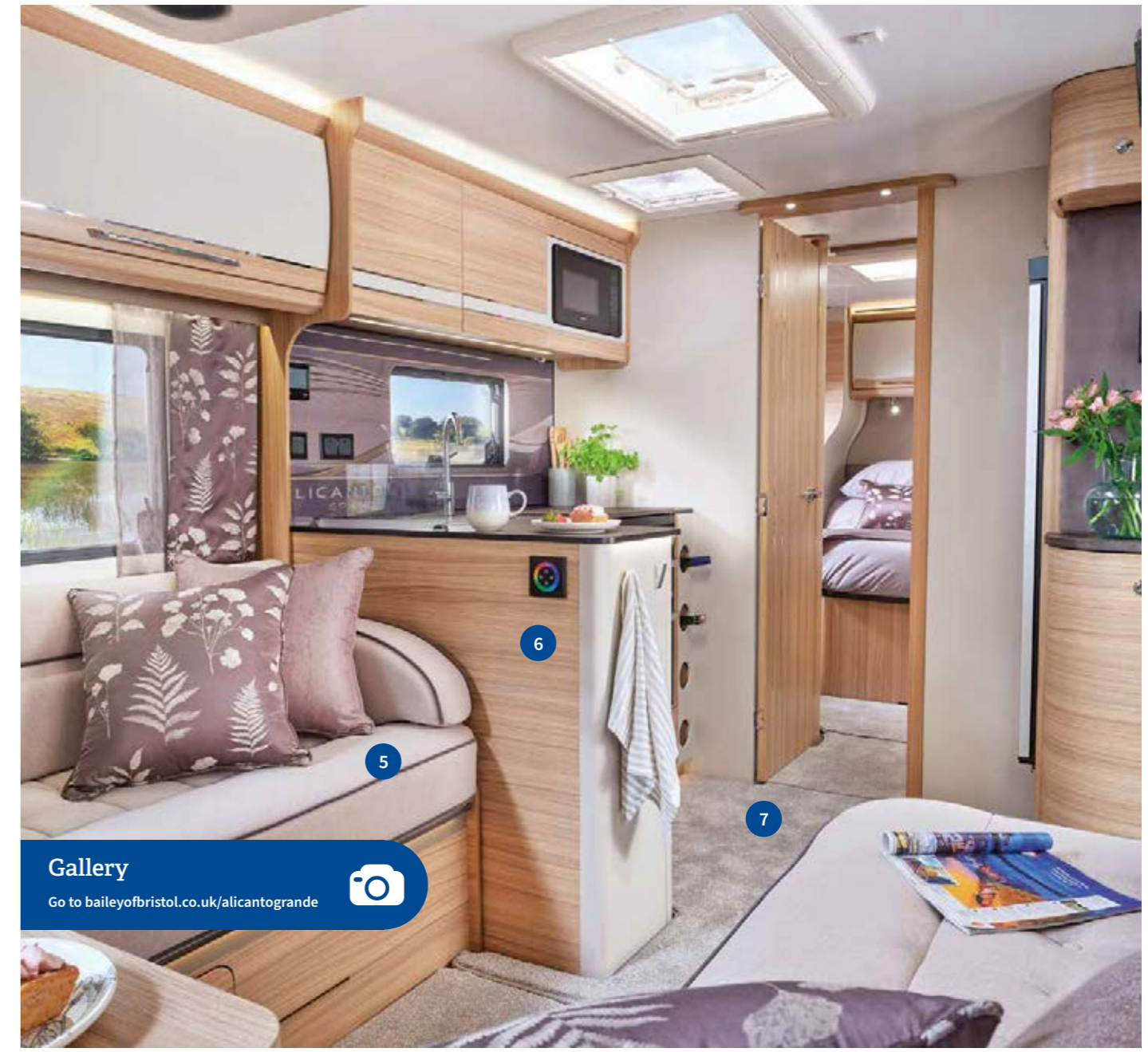

**Gallery**  
Go to [baileyofbristol.co.uk/alicantogrande](http://baileyofbristol.co.uk/alicantogrande)



Model Lisbon

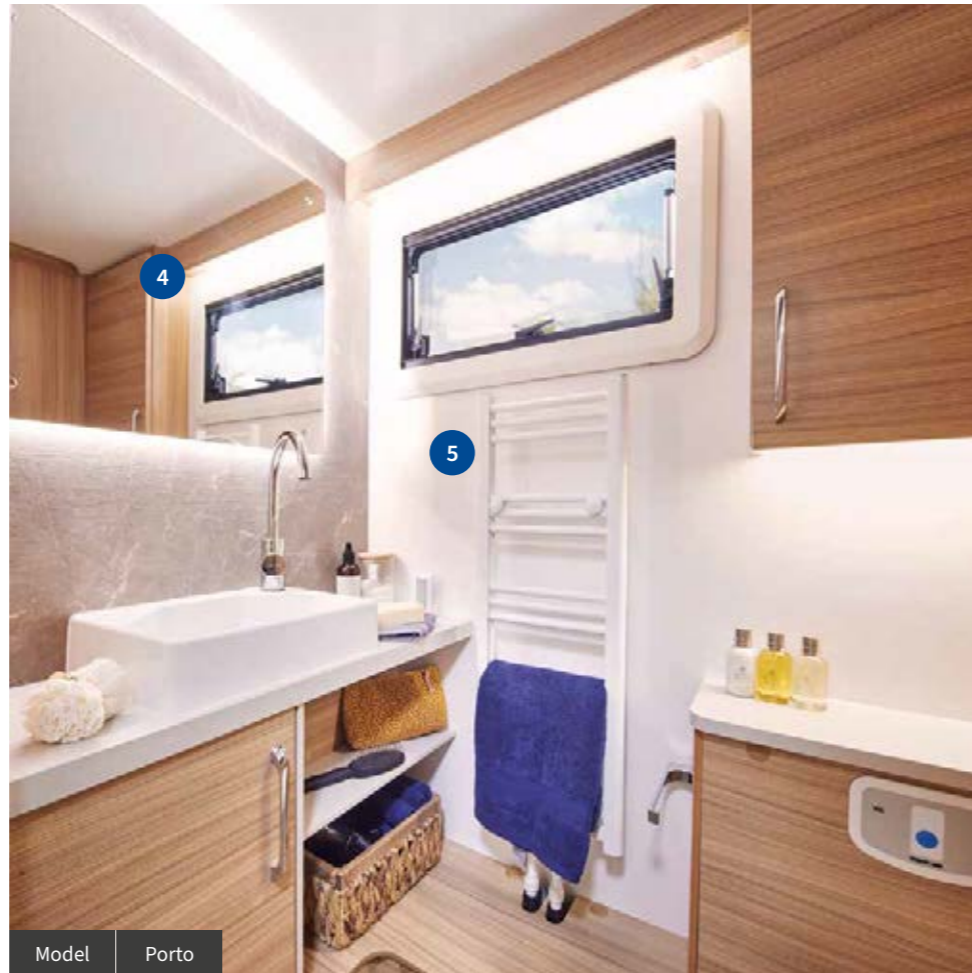

Model Porto



Model Porto

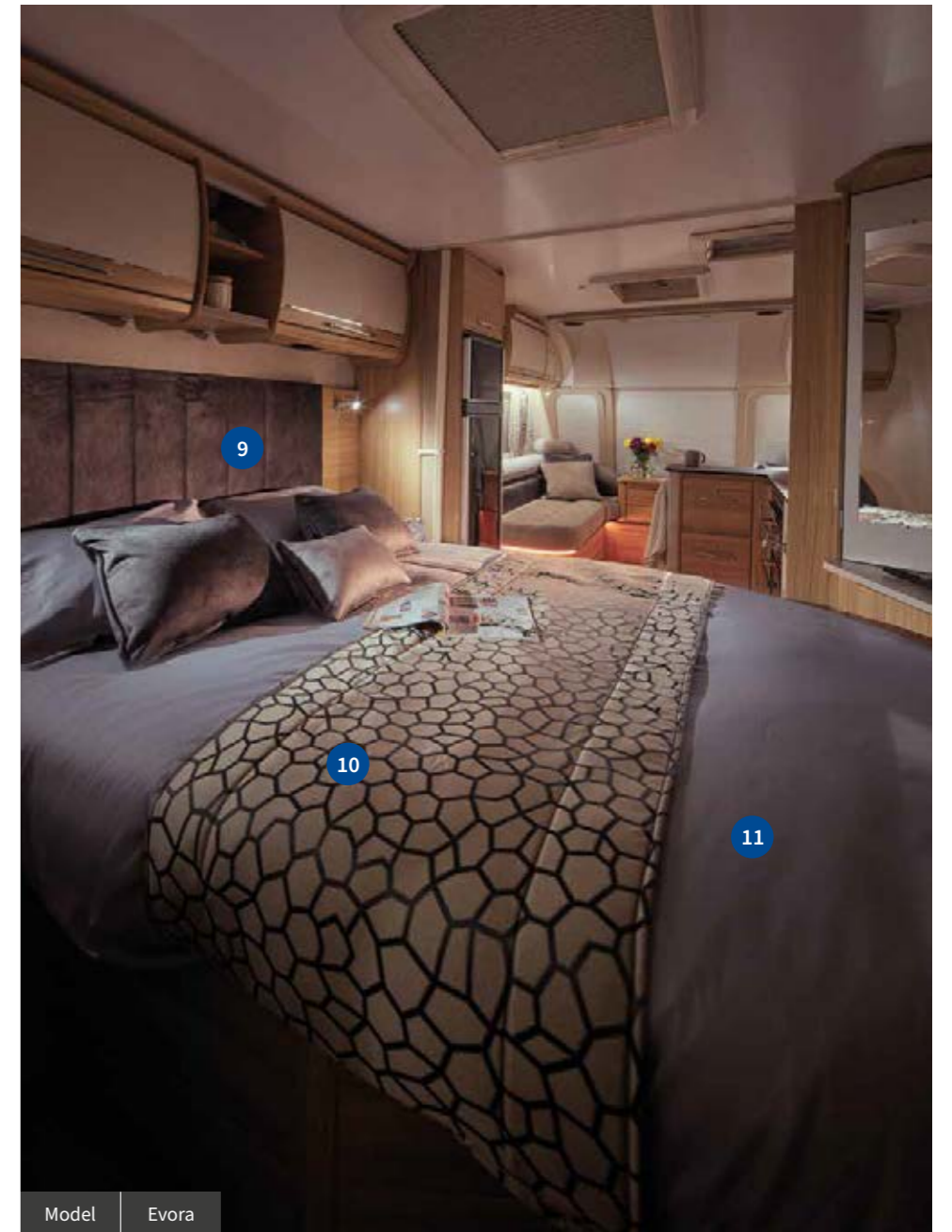

Model Evora

- 1** New branded 700 watt integrated microwave oven with non-moving ceramic hot plate
- 2** Thetford dual fuel hob with electric hotplate and three gas burners
- 3** New built-in kitchen wine rack
- 4** New backlit washroom mirror
- 5** New washroom heated towel rail (twin axle only)
- 6** New Belfast style washroom hand basin with swan neck tap

- 7** Two-drawer front chest with slide out occasional table and soft close drawers
- 8** New standard 'Portobello' soft furnishings
- 9** New king-size fixed island bed with full width back lit soft touch fixed headboards
- 10** Bespoke caravan bedding sets to coordinate with caravan soft furnishings (cost option)
- 11** New superior pocket sprung 'Poise' fixed bed mattress



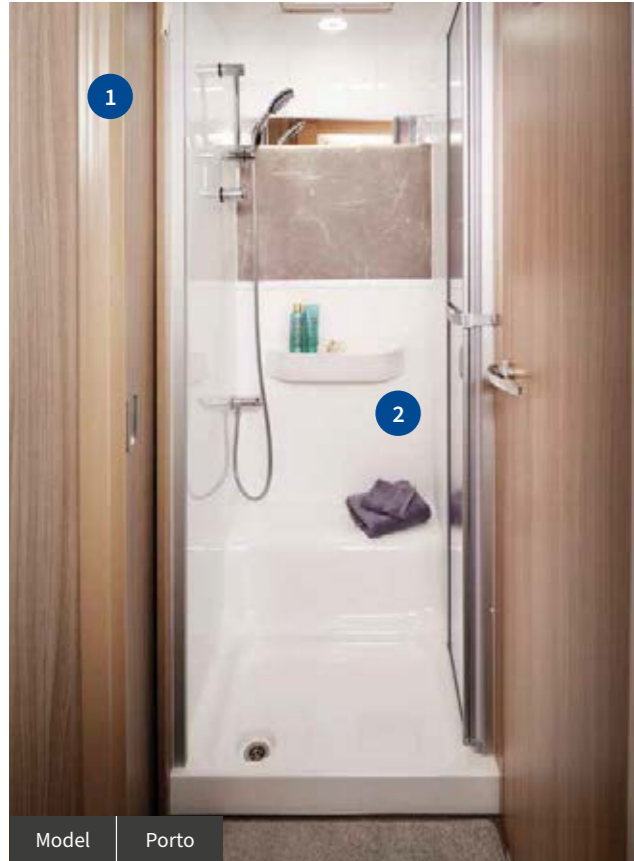

Model Porto

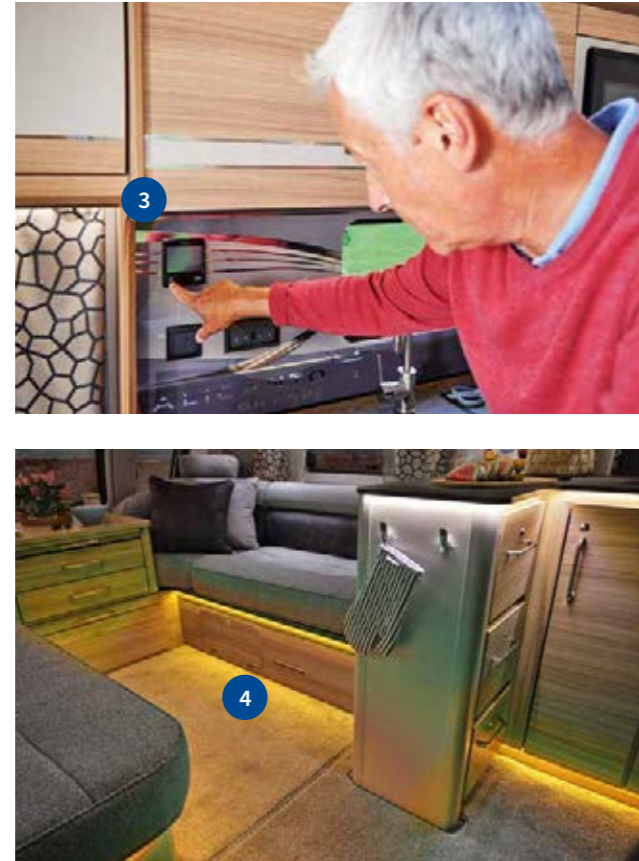

- 1** Large white fully lined square shower cubicle with bi-fold partition door and integral lighting
- 2** **New** in-shower moulded storage shelf
- 3** Alde heating touch screen user-friendly control panel
- 4** **New** RGB colour change ambient lighting system

- 5** Dometic 10-series 153 litre electronic fridge freezer with universal handed door mechanism and high security travel lock (twin axle model only)
- 6** **New** branded Perspex kitchen splashback with chrome detailing
- 7** **New** under-mount circular sink with swan-neck mixer tap, flush fit cover and integrated draining area
- 8** Bedside table and drawers



Model Porto

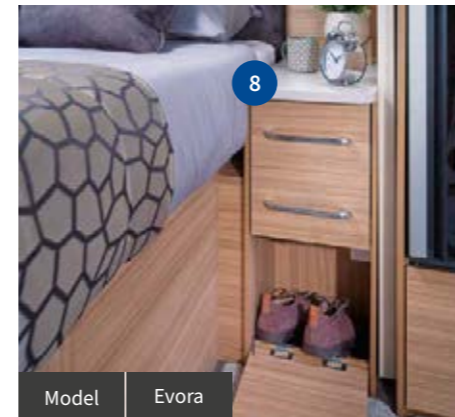

Model Evora



- 9** **New** wireless charging pad with two integrated USB points
- 10** **New** easy access rear exterior through-boot (model specific)
- 11** AL-KO AKS 3004 stabiliser AL-KO shock absorbers

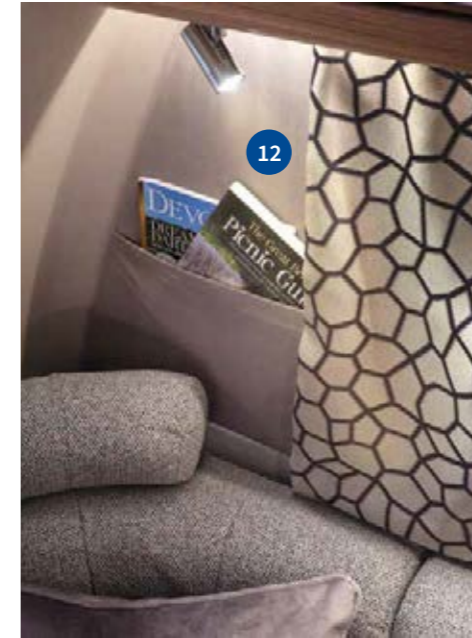

Model Lisbon



- 12** Front corner wall-mounted soft touch storage pouches
- 13** **New** rooflight mounted Omnivent extractor fan above kitchen
- 14** **New** Avtex mobile WiFi system



- 15** **New** optional 'Latimer' soft furnishings with practical Aquaclean base fabric helps to eliminate the majority of household stains with just water



[Find your Retailer](#) Go to [baileyofbristol.co.uk/find-a-retailer](http://baileyofbristol.co.uk/find-a-retailer)

# Specification



## Exterior features

- High performance GRP skinned 'Polar White' Alu-Tech bodyshell (Go to page 4 to find out more about our patented construction)
- AL-KO one-piece galvanised steel chassis, braking system and running gear
- **New** aerodynamic front profile
- **New** flush-fit single piece front impact resistant bumper with integral chrome capped grab handles and step up a-frame fairing
- **New** flush-fit single piece rear impact resistant bumper with integral light cluster
- **New** rear vertical pillar mouldings with integral chrome capped grab handles
- 'Diamond cut' style 15" (single axle models) or 14" (twin axle models) TUV tested alloy wheels
- **New** front and rear heavy duty corner steadies
- **New** vertical infinity front window and moulded surround with integral task lighting and speakers
- **New** pleated cassette blinds to front three windows
- **New** flush fit 'Piuma' side windows with integrated framed flyscreen and blinds
- Midi Heki rooflights located throughout the main habitation areas
- Hartal GRP skin two-part large aperture exterior door with window, waste bin and dustpan and brush, Hartal pleated full length flyscreen and exterior door drip tray

- **New** easy access rear exterior through-boot (model specific)
- **New** offside exterior service light
- **New** 'Alicanto Series 2' graphics scheme

## Living room

- **New** Bailey 'Light Oak' furniture finish
- **New** dual finish 'Satin Cashmere' British design overhead curved locker doors with 'Light Oak' contrasting stripe
- Premium quality chrome finish fixture and fittings
- **New** streamline front corner lockers
- 'Light Oak' finish freestanding table with dedicated storage
- Two-drawer front chest with slide out occasional table and soft close drawers
- Beech slat seat bases with sprung hinged tops for extra comfort and ease of access
- Conventional cushion construction with fully sprung knee rolled base cushions, foam filled back rests and curved corner sections with removable head rests, all featuring premium quality fabrics
- **New** 'Hazelnut' deep pile loose fit drop in carpets
- **New** standard 'Portobello' soft furnishings with co-ordinating curtain panels, one bolster cushion and four large square scatter cushions

- **New** optional 'Latimer' soft furnishings with practical 'Aquaclean' fabric, co-ordinating curtain panels, one bolster cushion and four large square scatter cushions

## Entertainment

- External satellite connection point
- Status 570 telescopic directional digital television aerial
- Up to two TV stations with 230v, 12v and two aerial sockets
- **New** two TV wall mounts and one TV bracket
- **New** branded DAB Radio with USB connection point and Bluetooth capability
- **New** additional twin speakers in rear bedrooms
- **New** Avtex mobile WiFi system (including introductory data and support package)

## Bedroom

- **New** king-size fixed island beds with aluminium frames and gas strut assisted opening mechanism
- **New** superior pocket sprung 'Poise' fixed bed mattress
- Beech slat bed bases with sprung hinged tops for extra comfort and ease of access
- **New** full width back lit soft touch fixed bed headboards

- **New** dual shaped wardrobes to maximise fixed bed width with mattress height storage cubby holes (model specific)
- **New** bedside storage compartments

## Kitchen

- **New** rooflight mounted Omnivent extractor fan above kitchen
- L-shape kitchen design with dedicated cutlery drawer with up to 25% more worktop surface and 30% more storage
- 'Slate Grey marble' finish kitchen worktop laminate
- Drop down hob cover worktop in matching 'Slate Grey' finish
- **New** under-mount circular sink with swan-neck mixer tap, flush fit cover and integrated draining area
- **New** branded Perspex kitchen splashback with chrome detailing
- Soft close kitchen drawers with cutlery tray
- **New** built-in kitchen wine rack
- **New** Dometic 133 litre tower refrigerator and 12 litre freezer with universal handed door and high security travel lock (single axle models only)
- Dometic 10-series 153 litre electronic fridge freezer with universal handed door mechanism and high security travel lock (twin axle models only)
- Thetford 'K-Series' combined oven, grill and hob with electronic ignition and flame failure device

- Thetford dual fuel hob with electronic hot plate and three gas burners
- **New** branded 700 watt integrated microwave oven with non-moving ceramic hot plate

## Bathroom

- **New** 'Cashmere' finish washroom worktop laminate
- Inboard shower unit with ceramic ball mixer tap and Ecocamel shower head
- Large white fully lined square shower cubicle with bi-fold partition door and integral lighting
- Ceiling mounted pull down hanging rail on shower hood
- **New** in-shower moulded storage shelf
- **New** Belfast style washroom hand basin with swan neck tap and full decorative splashback
- **New** backlit washroom mirror
- Built in Thetford C-260 cassette toilet with remote header tank and recessed toilet roll storage shelf

## Electrical

- Truma 80 watt solar panel
- **New** offside 230v power inlet for mains hook-up and Whale Easi-Slide cover
- **New** exterior 230v socket with integrated aerial jack outlet and Whale Easi-Slide cover

- 12v internal lighting system including LED down-lighters and directional spotlights plus ambient over locker and mid-level feature lighting
- **New** RGB colour change ambient lighting system
- 230v power supply with up to six interior sockets
- Four USB points mounted in directional spotlights
- **New** wireless charging pad with two integrated USB points
- **New** centrally located electrical control panel

## Heating and plumbing

- Alde Hydronic Compact 3020 programmable radiator heating system with combined water heating
  - Alde 3020 boiler for improved fuel economy
  - Dual fuel 6.4kw gas and up to 3.15kw electric power sources
  - Alde touch screen user-friendly control panel with back up battery for uninterrupted programming
  - Washroom panel radiator (single axle)
  - **New** washroom heated towel rail (twin axle only)
- On-board 40L water tank (twin axle models only)
- Whale high flow submersible pump
- Truma gas BBQ point with **new** Whale Easi-Slide cover

## Safety and security

- **New** high security exterior door lock
- AL-KO ATC trailer control system
- AL-KO AKS 3004 stabiliser
- AL-KO shock absorbers
- AL-KO chassis mounted spare wheel carrier and steel spare wheel
- AL-KO caravan jack
- AL-KO Secure portable wheel lock (two for twin axle models)
- TRACKER Monitor Thatcham CAT 7 approved Stolen Vehicle Recovery System (including first three months subscription fee)
- TRACKER PIR activated intruder alarm featuring a tilt sensor and key fob operation

## Warranty

- Supplied with a six-year transferable bodyshell integrity warranty and a three-year transferable manufacturer's warranty\*
- Four-year transferable extension to bodyshell integrity warranty (making ten years in total) and/or three-year transferable extension to manufacturer's warranty (making six years in total) available as cost options\*

## Optional extras

- **New** optional 'Latimer' soft furnishings with Aquaclean fabric helps to eliminate the majority of household stains with just water
- Bespoke caravan bedding sets to co-ordinate with caravan soft furnishings

\*Terms and conditions apply. Please visit [baileyofofbristol.co.uk/warranties-servicing](http://baileyofofbristol.co.uk/warranties-servicing) for more information.

**For a full list of specifications**  
Go to [baileyofofbristol.co.uk/allicantogrande](http://baileyofofbristol.co.uk/allicantogrande)



**Lisbon** 4↑

Internal Length	6.112m/20'1"
Shipping Length	7.381m/24'3"
Overall Width	2.450m/8'0"
Overall Height	2.605m/8'7"
Internal Headroom	1.960m/6'5"
Awning Size	1031cm
Tyre Sizes	195/70 R15
MTPLM	1700kg
MRO	1546kg
Total User Payload	154kg

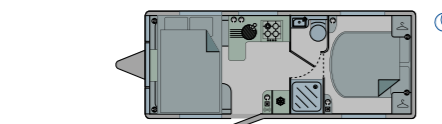
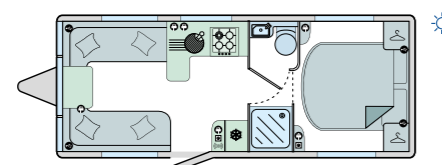

**Bed Sizes**

Front Double	2.12m x 1.13m / 7'0" x 3'9"
Front N/S Single	1.77m x 0.64m / 5'9" x 2'1"
Front O/S Single	1.74m x 0.64m / 5'8" x 2'1"
Rear Fixed Double	1.90m x 1.53m / 6'3" x 5'0"



**Evora** 4↑ **Twin Axle**

Internal Length	6.334m/20'9"
Shipping Length	7.862m/25'10"
Overall Width	2.450m/8'0"
Overall Height	2.605m/8'7"
Internal Headroom	1.960m/6'5"
Awning Size	1083cm
Tyre Sizes	185/65R14
MTPLM	1855kg
MRO	1694kg
Total User Payload	160kg

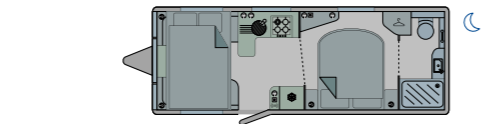
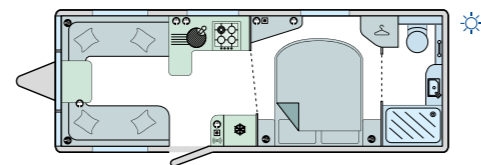

**Bed Sizes**

Front Double	2.12m x 1.21/ 7'0" x 4'0"
Front N/S Single	1.85 x 0.64m / 5'11" x 2'1"
Front O/S Single	1.82m x 0.64m / 5'11" x 2'1"
Rear Fixed Double	1.90m x 1.53m / 6'3" x 5'10"



**Porto** 4↑ **Twin Axle**

Internal Length	6.334m/20'9"
Shipping Length	7.862m/25'10"
Overall Width	2.450m/8'0"
Overall Height	2.605m/8'7"
Internal Headroom	1.960m/6'5"
Awning Size	1083cm
Tyre Sizes	185/65 R14
MTPLM	1847kg
MRO	1687kg
Total User Payload	160kg

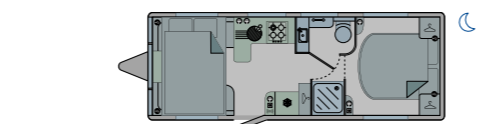
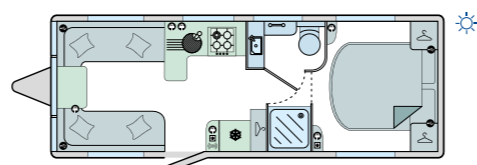

**Bed Sizes**

Front Double	2.12m x 1.21m / 7'0" x 4'0"
Front N/S Single	1.85m x 0.64m / 6'0" x 2'1"
Front O/S Single	1.82m x 0.64m / 5'11" x 2'1"
Rear Fixed Double	1.90m x 1.53m / 6'3" x 5'0"

A tolerance in the MRO has been allowed for in the calculations of Payload Margins. The awning length measurement shown is to be interpreted as a guide only and an enquiry should be made to individual awning manufacturers as to the correct size. Bed sizes are measured at the widest point of the bed.



Compare Alicanto Grande online Go to [baileyofbristol.co.uk/compare-alicanto](http://baileyofbristol.co.uk/compare-alicanto)



Lavishly accessorised as standard; the Alicanto Grande is the ultimate in luxury touring. Enhance the refined design with an exclusive range of accessories specially made to match the five-star experience.

Continue the sophisticated Alicanto style throughout with a choice of bespoke bedding and soft furnishings sets, hi-tech entertainment systems, and a tailor-made washroom window privacy screen to create your own private retreat.

Preserve the elegant Alicanto exterior with an exclusive selection of towing, wheel, and hitch covers that will add an extra element of class and safety to your van, whilst celebrating the Bailey brand.

Discover over 25,000 Bailey parts and accessories at [primaleisure.com](http://primaleisure.com) or through your local Bailey Retailer.

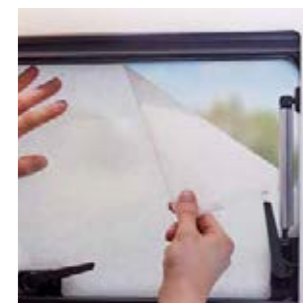
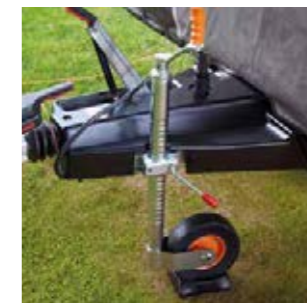



Stylish & spacious

# TIME OUT (AND STRETCH OUT)



## Favourite facts

- Truma 100 watt solar panel for off-grid holidays
- AL-KO ATC trailer control system and stabiliser hitch
- Tracker Retrieve Stolen Vehicle Recovery system
- Up to 25% additional living space
- Four-season all weather sustainability with Truma Combi blown air heating system
- G-shaped lounge design or U-shaped dinette area (model specific)

8ft  
WIDE

## Get to know Pegasus Grande SE

The extra-wide Pegasus Grande SE has been designed to offer a unique range of generous layouts, perfect for relaxing or entertaining in style.

7 Models

4-6 Berths

A fresh take on a firm favourite, the Pegasus Grande SE gives this familiar Bailey range an all-new look, inside and out. More space meets more choice.

With seven unique layouts offering up to 25% more space inside, the 8ft wide Pegasus is both versatile and comprehensively specified. Brimming with features, it combines smart design with stylish touches, so you have everything you'll need to enjoy your holiday, no matter if you're hitting the road or finding a spot for the season. Comfort and convenience await.



Model Brindisi



### Key features

- 1 New Bailey 'Light Oak' furniture finish
- 2 Vertical front skylight surround with integral task lighting
- 3 G-shaped front lounge with sliding front dinette table (model specific)
- 4 New optional 'Barbican' soft furnishings
- 5 New domestic style sofa seating featuring premium quality fabrics and knee rolled sprung base cushions seat bases
- 6 Bespoke caravan bedding sets to co-ordinate with caravan soft furnishings (cost option)

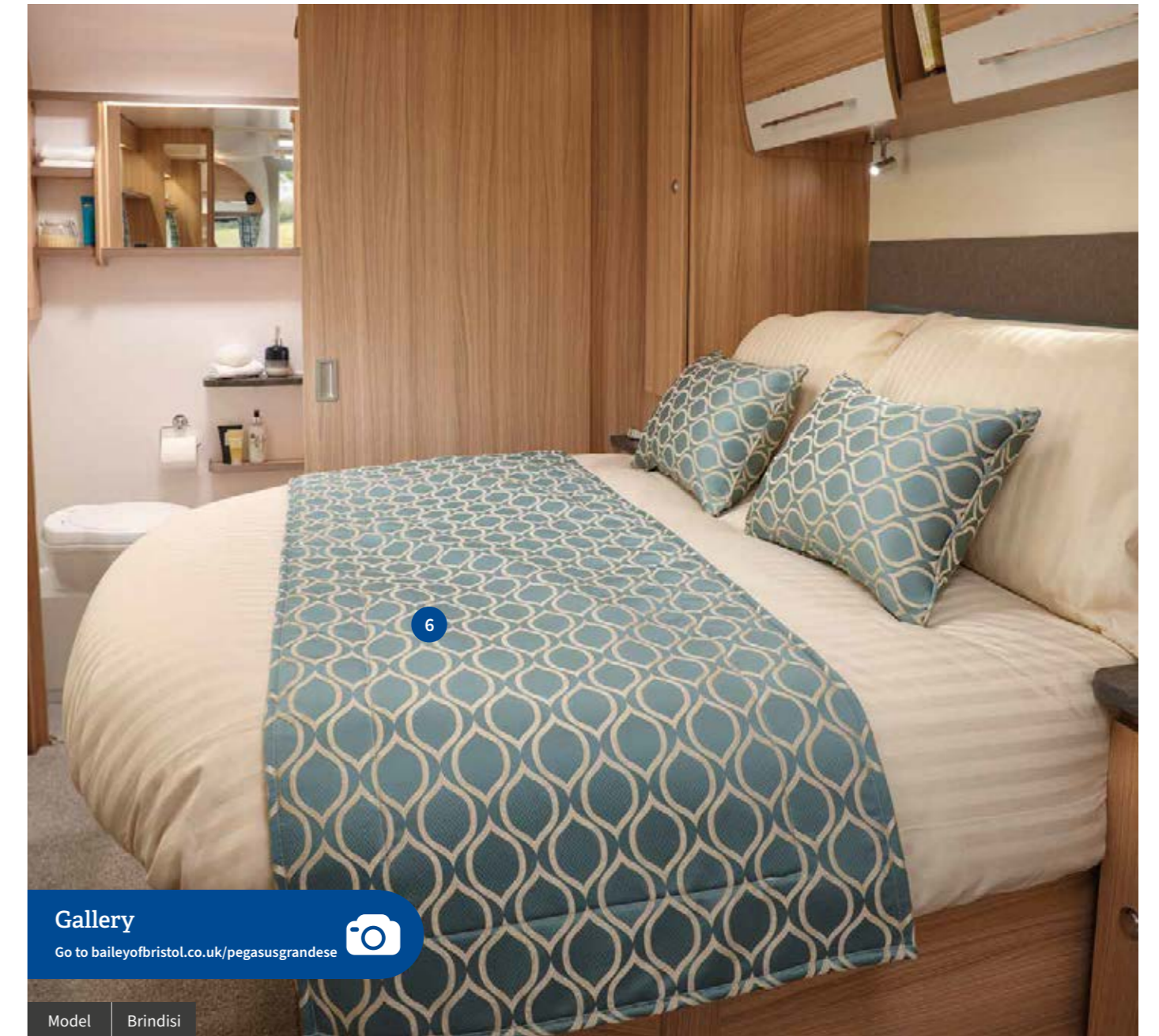

### Gallery

Go to [baileyofbristol.co.uk/pegasusgrandese](http://baileyofbristol.co.uk/pegasusgrandese)

Model Brindisi



- 1 Full width backlit washroom mirror (model specific)
- 2 White gloss shower cubicle with bi-fold partition door and integral lighting
- 3 New branded Perspex kitchen splashback with silver detailing

- 4 New stainless steel round kitchen sink with concealed fixings, mixer tap, washing up bowl and drainer
- 5 Thetford dual fuel hob with electric hotplate and three gas burners
- 6 700 watt Dometic microwave oven with non-moving ceramic hot plate



Model Bologna



Model Bologna

- 7 New standard 'Goldhawk' soft furnishings
- 8 New dual finish Italian design overhead curved locker doors with 'canvas' textured contrasting stripe

- 9 Superior foam fixed bed mattress construction

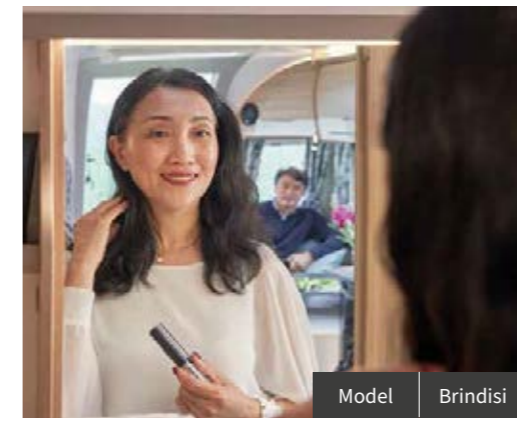

Model Brindisi



Model Messina



Model Bologna



Model Bologna

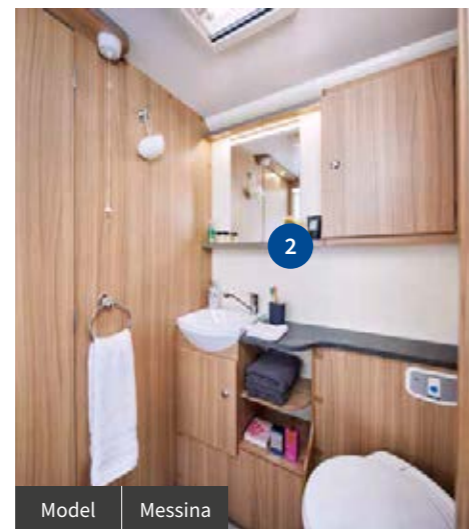

Model Messina

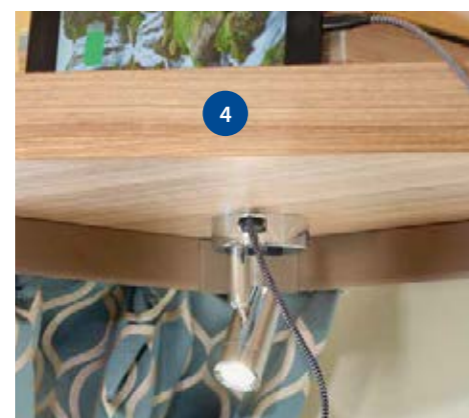

Model Ancona

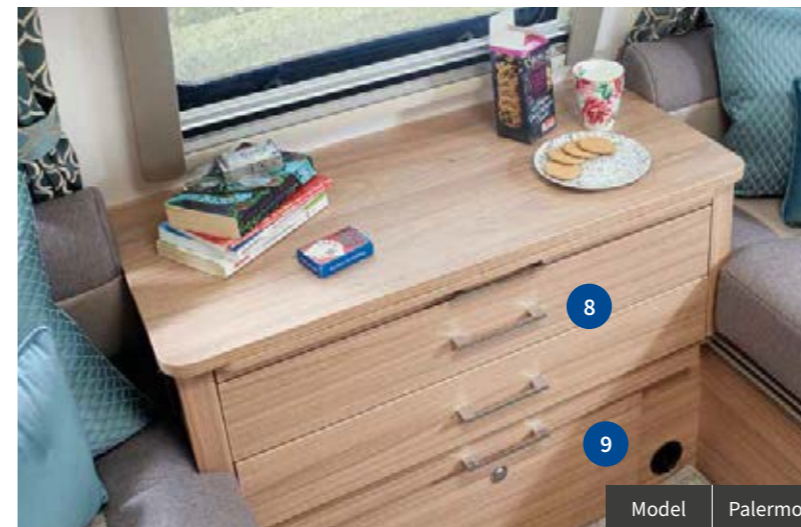
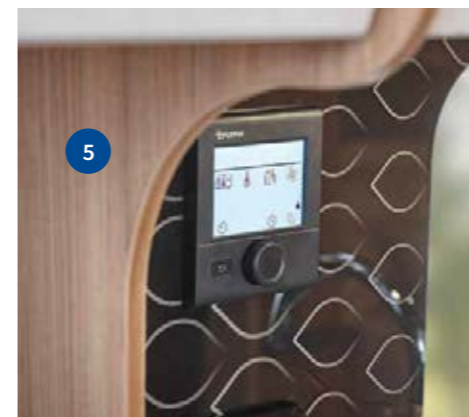

Model Palermo

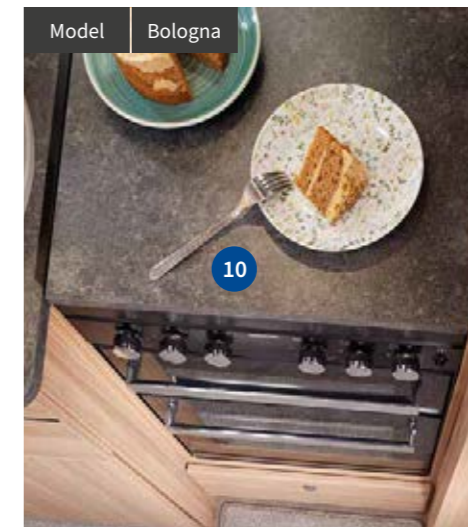

Model Bologna



- 1 **New** Dometic 10-series 153 litre electronic fridge freezer with universal handed door mechanism (model specific)
- 2 Washroom hand basin and mixer tap with integrated storage cupboard
- 3 **New** branded DAB radio with USB connection point and Bluetooth capability
- 4 USB sockets in directional spotlights

- 5 Truma user-friendly digital control panel with adjustable fan and water boost functions
- 6 Through-boot easy access large exterior storage locker (model specific)
- 7 Truma 100 watt solar panel
- 8 Two-drawer front chest with slide out occasional table and soft close drawers (model specific)

- 9 **New** low level storage cupboard beneath front chest (model specific)
- 10 Drop-down hob cover worktop
- 11 **New** 'Pegasus Grande SE' graphics scheme and 'Dove Grey' sides

 **Find your Retailer**  
Go to [baileyofofbristol.co.uk/find-a-retailer](http://baileyofofbristol.co.uk/find-a-retailer)

# Specification



## Exclusive Pegasus Grande SE features

- **New** high performance GRP skinned 'Dove Grey' and 'Polar White' Alu-Tech Bodyshell
- **New** 'Pegasus Grande SE' graphics scheme
- **New** Bailey 'Light Oak' furniture finish
- **New** dual finish Italian design overhead curved locker doors with 'canvas' textured contrasting stripe
- **New** low level storage cupboard beneath front chest (model specific)
- **New** stainless steel round kitchen sink with concealed fixings, mixer tap, washing up bowl and drainer
- **New** branded Perspex kitchen splashback with silver detailing
- **New** Dometic 10-series 153 litre electronic fridge freezer with universal handed door mechanism (twin axle models only)
- **New** 700 watt Dometic microwave oven with non-moving ceramic hot plate
- **New** silver finish interior grab handle for ease of access in and out of the caravan
- **New** domestic style sofa seating featuring premium quality fabrics and knee rolled sprung base cushions seat bases for enhanced comfort
- **New** standard 'Goldhawk' soft furnishings with co-ordinating curtains, two large square and two small rectangular scatter cushions
- **New** optional 'Barbican' soft furnishings with co-ordinating curtains, two large square and two small rectangular scatter cushions
- **New** 'Hazelnut' loose fit carpet
- **New** branded DAB radio with USB connection point and Bluetooth capability

## Exterior features

- AL-KO one-piece galvanised steel chassis, braking system and running gear
- Flush-fit single piece front and rear impact resistant bumper with integral grab handles and step up A-frame fairing
- 'Silver' 15" (single axle models) or 14" (twin axle models) TUV tested alloy wheels
- Aerodynamically profiled double glazed Polyplastic opening vertical front skylight and windows throughout
- Vertical front skylight surround with integral task lighting
- Remis 2-part pleated flyscreen and blind to vertical skylight and Remis pleated flyscreen and blinds to principal windows
- Midi and mini Heki rooflights located throughout the habitation area
- Hartal GRP skin two-part large aperture exterior door with window, waste bin and dustpan and brush, Hartal pleated full length flyscreen and exterior door drip tray
- Through-boot easy access large exterior storage locker (model specific)
- Easy access exterior storage locker (model specific)

## Living room

- Premium quality chrome finish fixture and fittings
- 'Nordic Stone' finish freestanding table with dedicated storage
- Two-drawer front chest with slide out occasional table and soft close drawers (model specific)
- G-shaped front lounge with sliding front dinette table (model specific)
- Central U-shaped dinette area with sliding table (model specific)
- Beech slat seat bases with sprung hinged tops for extra comfort and ease of access
- Domestic style sofa seating featuring premium quality fabrics and sprung seat bases for enhanced comfort
- Interior grab handle for ease of access in and out of the caravan

## Entertainment

- Status 570 telescopic directional digital television aerial
- TV station with 230v, 12v and up to two aerial socket
- TV wall mount (model specific)
- Branded dual cone stereo speakers for superior sound quality
- Pre-wired for WiFi (Retailer fit)

## Bedroom

- Beech slat bed bases with sprung hinged tops for extra comfort and ease of access (model specific)
- Fixed double beds with aluminium frames and gas strut assisted opening mechanism (model specific)
- Superior foam fixed bed mattress construction
- Padded headboards for fixed beds (model specific)
- Fold-out pull-up bunk (model specific)

## Kitchen features

- 'Nordic Stone' kitchen worktop laminate
- Drop down hob cover worktop in matching 'Nordic Stone' finish
- Integral dedicated cutlery tray
- Remis splash proof roller blind to kitchen window
- Dometic 103 litre refrigerator and 12 litre freezer with electronic ignition (single axle models)
- Thetford 'K-Series' combined oven, grill and hob with electronic ignition and flame failure device
- Thetford dual fuel hob with electric hotplate and three gas burners

## Bathroom features

- 'Nordic Stone' washroom worktop laminate
- White gloss shower cubicle with bi-fold partition door and integral lighting
- Bathroom storage cupboard
- Full width washroom mirror (model specific)
- Washroom hand basin and mixer tap
- Thetford C-260 cassette toilet with integrated header tank (model specific)
- Built in Thetford C-260 cassette toilet with remote header tank (model specific)

## Electrical

- Truma 100 watt solar panel
- Exterior 230v socket
- 12v internal lighting system including LED down-lighters and directional spotlights plus ambient over locker lighting
- 230v power supply with up to six interior sockets
- Up to four USB sockets in directional spotlights
- Centrally located electrical control panel

## Heating and plumbing

- Truma Combi 4 heating system, combined water and room heating with dual fuel 4kw gas and 1.8kw electric power sources (single axle models)
- Truma Combi 6 heating system, combined water and room heating with dual fuel 6kw gas and 1.8kw electric power sources (twin axle models)
- Truma user friendly digital control panel with adjustable fan and water boost functions
- Whale high flow submersible pump
- Truma gas BBQ point

## Safety and security

- AL-KO ATC trailer control system
- AL-KO AKS 3004 stabiliser
- AL-KO chassis mounted spare wheel carrier and steel spare wheel
- AL-KO wheel lock receiver
- TRACKER Retrieve Stolen Vehicle Recovery System (including first three months subscription fee)

## Warranty

- Supplied with a six-year transferable bodyshell integrity warranty and a three-year transferable manufacturer's components warranty\*
- Four-year transferable extension to bodyshell integrity warranty (making 10 years in total) and/or three-year transferable extension to manufacturer's warranty (making six years in total) available as cost options\*

## Optional extras

- Optional 'Barbican' soft furnishings
- Bespoke caravan bedding sets to co-ordinate with caravan soft furnishings (model specific)

\*Terms and conditions apply. Please visit [baileيوفbristol.co.uk/warranties-servicing](http://baileيوفbristol.co.uk/warranties-servicing) for more information.



**For a full list of specifications**

Go to [baileيوفbristol.co.uk/pegasusgrandese](http://baileيوفbristol.co.uk/pegasusgrandese)



**Rimini** 4↑

Internal Length	5.904m/19'4"
Shipping Length	7.381m/24'3"
Overall Width	2.450m/8'0"
Overall Height	2.608m/8'7"
Internal Headroom	1.960m/6'5"
Awning Size	1033cm
Tyre Sizes	195/70R15
MTPLM	1556kg
MRO	1401kg
Total User Payload	155kg

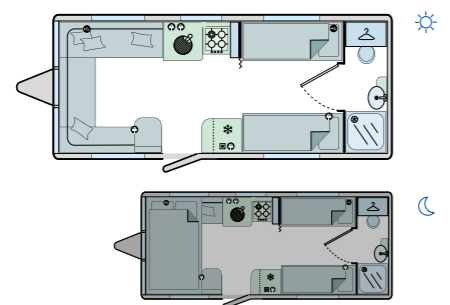

**Bed Sizes**

Front Double	2.23m x 1.23m/7'4" x 4'0"
Rear N/S Fixed Single	1.89m x 0.77m/6'2" x 2'6"
Rear O/S Fixed Single	1.89m x 0.77m/6'2" x 2'6"



**Brindisi** 4↑

Internal Length	5.904m/19'4"
Shipping Length	7.381m/24'3"
Overall Width	2.450m/8'0"
Overall Height	2.608m/8'7"
Internal Headroom	1.960m/6'5"
Awning Size	1030cm
Tyre Sizes	195/70R15
MTPLM	1539kg
MRO	1384kg
Total User Payload	155kg

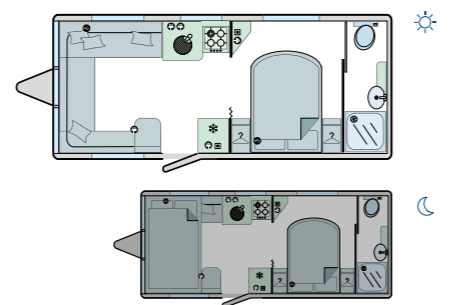

**Bed Sizes**

Front Double	2.23m x 1.23m/7'4" x 4'0"
Rear Fixed Double	1.91m x 1.39m/6'3" x 4'7"



**Ancona** 5↑

Internal Length	5.904m/19'4"
Shipping Length	7.381m/24'3"
Overall Width	2.450m/8'0"
Overall Height	2.608m/8'7"
Internal Headroom	1.960m/6'5"
Awning Size	1033cm
Tyre Sizes	195/70R15
MTPLM	1600kg
MRO	1435kg
Total User Payload	165kg

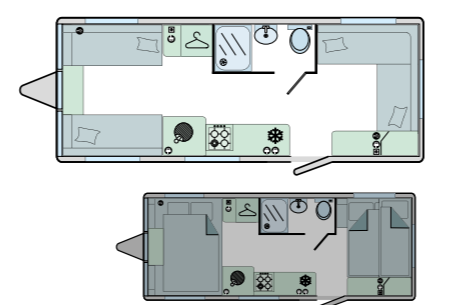

**Bed Sizes**

Front Double	2.23m x 1.46m/7'4" x 4'9"
Front N/S Single	1.90m x 0.65m/6'2" x 2'1"
Front O/S Single	1.90m x 0.65m/6'2" x 2'1"
Rear Double	1.82m x 1.58m/5'11" x 5'2"
Rear Fold-out Bunk	1.68m x 0.62m/5'6" x 2'0"



**Bologna** 4↑  
Twin Axle

Internal Length	6.334m/20'9"
Shipping Length	7.863m/25'10"
Overall Width	2.450m/8'0"
Overall Height	2.608m/8'7"
Internal Headroom	1.960m/6'5"
Awning Size	1077cm
Tyre Sizes	185/65R14
MTPLM	1656kg
MRO	1496kg
Total User Payload	160kg

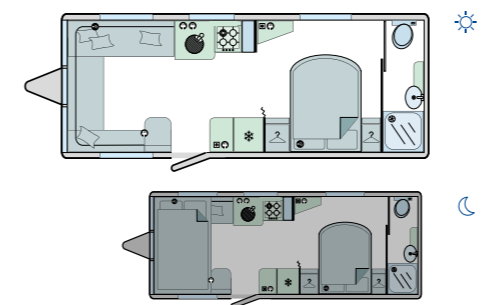

**Bed Sizes**

Front Double	2.23m x 1.29m/7'4" x 4'3"
Rear Fixed Double	1.91m x 1.39m/6'3" x 4'7"



**Messina** 4↑  
Twin Axle

Internal Length	6.334m/20'9"
Shipping Length	7.863m/25'10"
Overall Width	2.450m/8'0"
Overall Height	2.608m/8'7"
Internal Headroom	1.960m/6'5"
Awning Size	1077cm
Tyre Sizes	185/65R14
MTPLM	1698kg
MRO	1538kg
Total User Payload	160kg

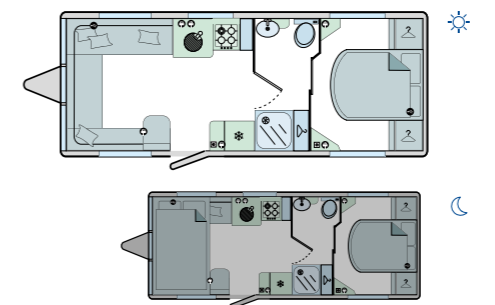

**Bed Sizes**

Front Double	2.23m x 1.29m/7'4" x 4'3"
Rear Fixed Double	1.86m x 1.39m/6'1" x 4'7"



**Palermo** 6↑  
Twin Axle

Internal Length	6.334m/20'9"
Shipping Length	7.863m/25'10"
Overall Width	2.450m/8'0"
Overall Height	2.608m/8'7"
Internal Headroom	1.960m/6'5"
Awning Size	1075cm
Tyre Sizes	185/65R14
MTPLM	1715kg
MRO	1535kg
Total User Payload	180kg

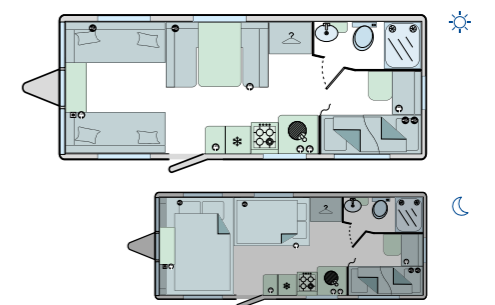

**Bed Sizes**

Front Double	2.17m x 1.46m/7'1" x 4'10"
Front N/S Single	1.87m x 0.63m/6'2" x 2'1"
Front O/S Single	1.90m x 0.63m/6'3" x 2'1"
Mid O/S Double	1.99m x 1.13m/6'6" x 3'9"
Rear N/S Fixed Bunks	1.87m x 0.70m/6'2" x 2'4"



**Turin** 6↑  
Twin Axle

Internal Length	6.334m/20'9"
Shipping Length	7.863m/25'10"
Overall Width	2.450m/8'0"
Overall Height	2.608m/8'7"
Internal Headroom	1.960m/6'5"
Awning Size	1077cm
Tyre Sizes	185/65R14
MTPLM	1724kg
MRO	1544kg
Total User Payload	180kg

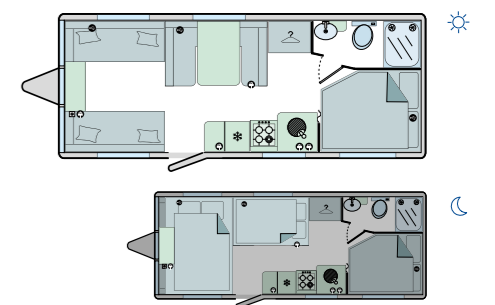

**Bed Sizes**

Front Double	2.17m x 1.46m/7'1" x 4'10"
Front N/S Single	1.87m x 0.63m/6'2" x 2'1"
Front O/S Single	1.90m x 0.63m/6'3" x 2'1"
Mid O/S Double	1.99m x 1.13m/6'6" x 3'9"
Rear Fixed Double	1.86m x 1.37m/6'1" x 4'6"

A tolerance in the MRO has been allowed for in the calculations of Payload Margins. The awning length measurement shown is to be interpreted as a guide only and an enquiry should be made to individual awning manufacturers as to the correct size. All Single Axle in 1600kg chassis. All Twin Axle in 1800kg chassis. Bed sizes are measured at the widest point of the bed.

Effortless & elegant

# FREE-STYLE LUXURY



## Favourite facts

- Vertical infinity front window – with a 50% increase on window size
- AL-KO ATC trailer control system and stabiliser hitch
- Tracker Monitor system with integral intruder alarm
- Truma 80 watt solar panel for off-grid holidays
- Four-season all weather sustainability with Alde radiator central heating system
- Stylish interiors featuring ‘Light Oak’ furniture and a choice of two luxurious soft furnishing schemes

## Get to know Unicorn

Effortless practicality meets simple elegance. Packed with new features, the new Unicorn range sets a new standard, so you can escape in both style and luxury.

7 Models

2-4 Berths

Our Unicorn range has become a firm favourite with the luxury market owner and this new fifth-generation Unicorn is no exception.

With seven models to choose from, the new Unicorn boasts style and luxury. Its specification ticks all the practicality boxes, as well as new stylish features; complete with a choice of two luxurious soft furnishing schemes. If that wasn't enough, the Unicorn offers an unmissable new look front exterior infinity window. Wherever you want to travel, look no further than the new Unicorn to travel in the height of luxury.



Model | Vigo

### Key features

- 1 **New** vertical front infinity window and moulded surround with integral task lighting and speakers
- 2 **New** streamline front corner lockers
- 3 **New** dual finish 'Satin Cashmere' British design overhead curved locker doors with 'Light Oak' contrasting stripe
- 4 **New** standard 'Chiswick' soft furnishings
- 5 Two-drawer front chest with slide out occasional table and soft close drawers
- 6 **New** conventional sprung cushion construction with knee roll base cushions and back rests, featuring premium quality fabrics
- 7 **New** Bailey 'Light Oak' furniture finish

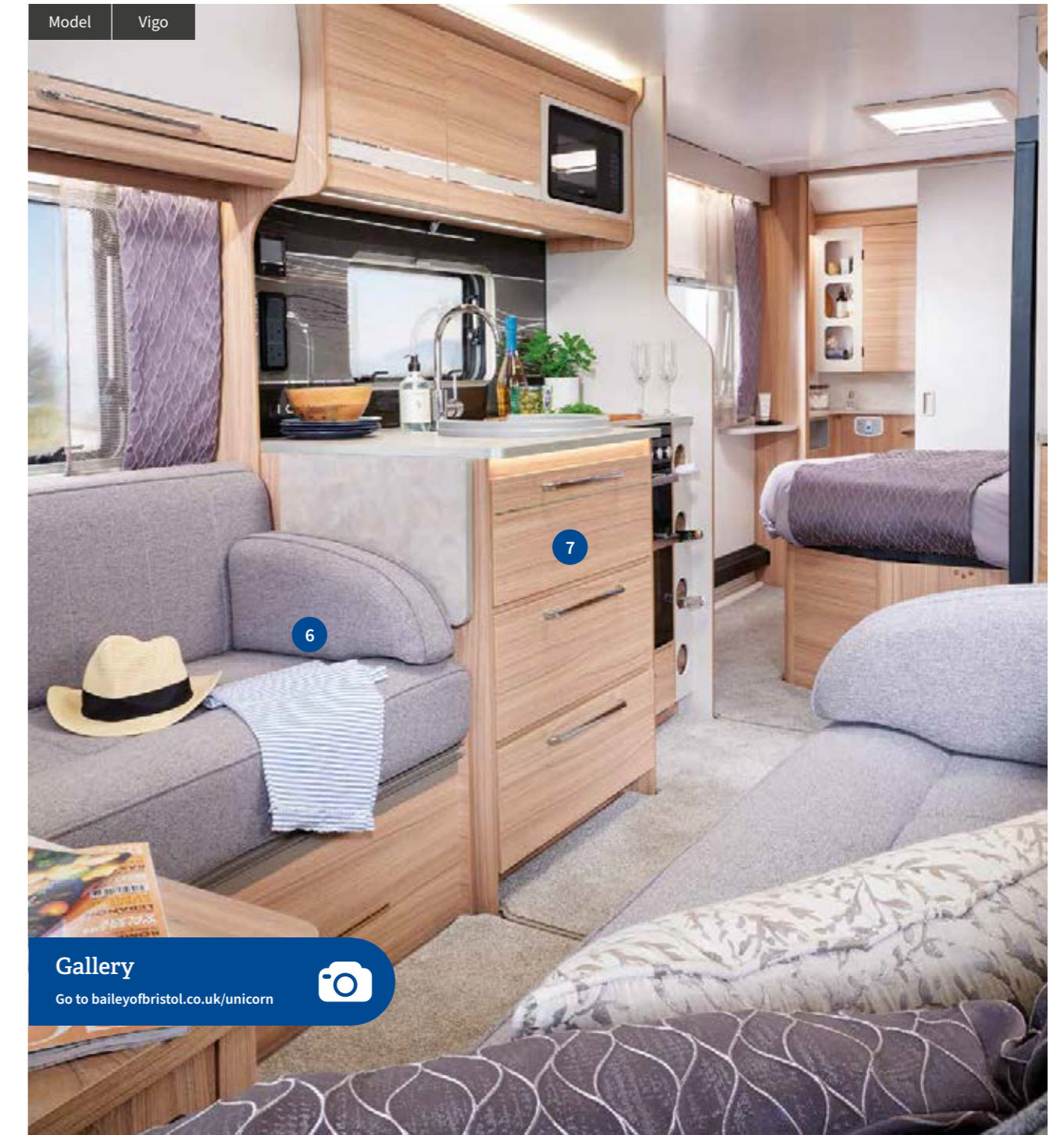

Gallery  
Go to [baileيوفbristol.co.uk/unicorn](https://baileيوفbristol.co.uk/unicorn)





Model Cartagena



Model Vigo

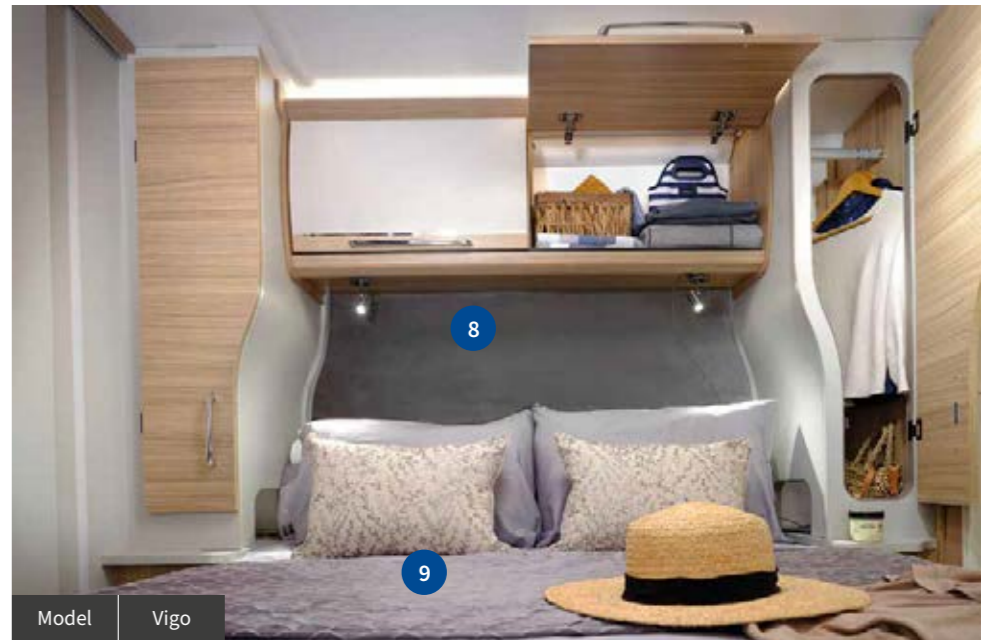

Model Vigo



Model Cadiz

- 1 Drop down kitchen worktop extension (model specific)
- 2 Drop down hob cover worktop
- 3 Thetford dual fuel hob with electric hotplate and three gas burners
- 4 New built-in kitchen wine rack (model specific)
- 5 New 700 watt Dometic microwave oven with non-moving ceramic hot plate

- 6 New backlit washroom mirror (model specific)
- 7 Large fully lined square shower cubicle with bi-fold partition door and integral lighting
- 8 New wider fixed double beds with full width soft touch headboards
- 9 Superior foam fixed bed mattress construction (model specific)
- 10 Bespoke caravan bedding sets to co-ordinate with caravan soft furnishings (cost option)

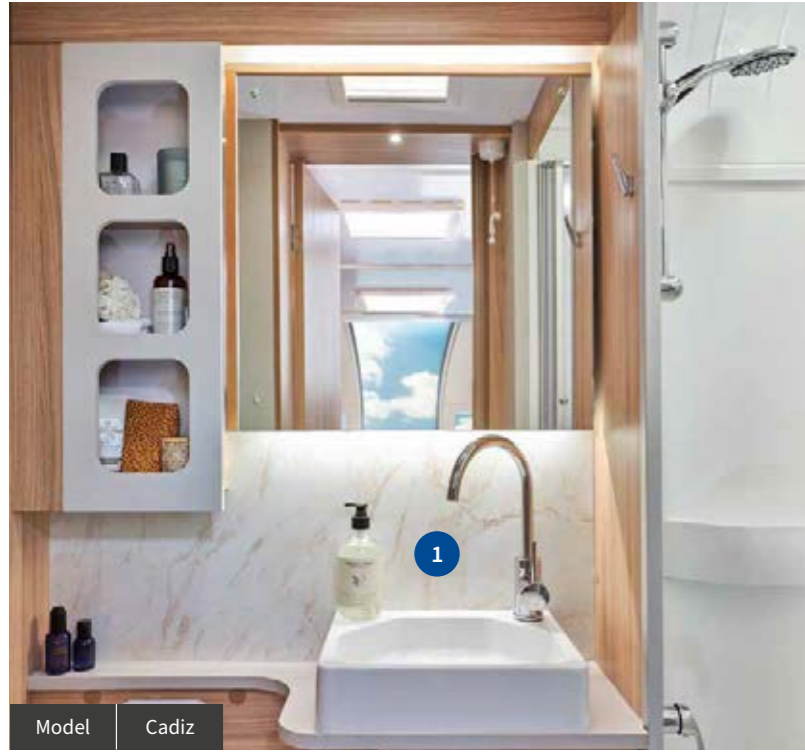

Model Cadiz

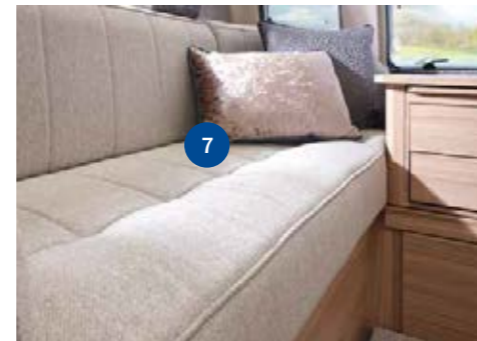
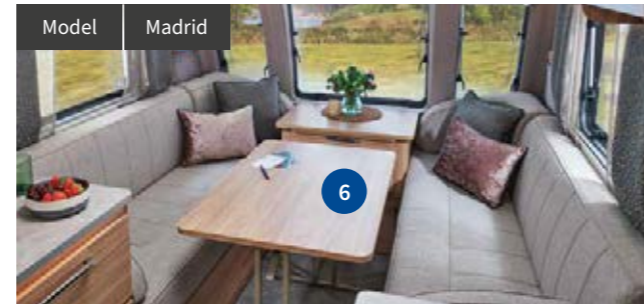
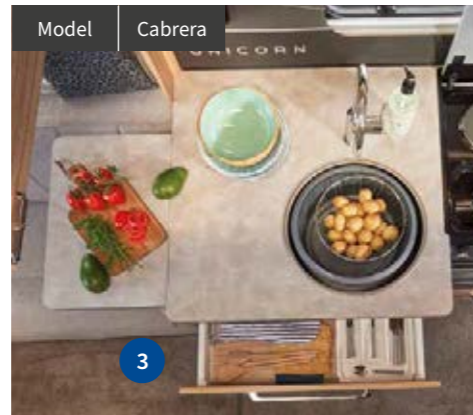
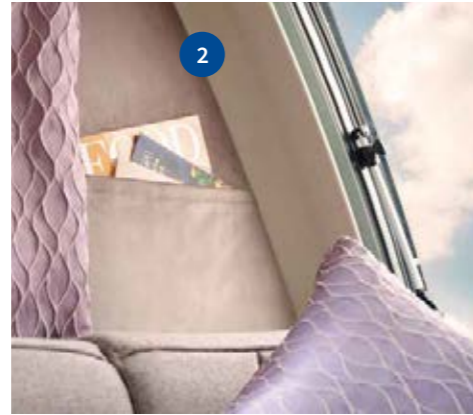

Model Madrid



Model Madrid



Model Madrid



Model Pamplona

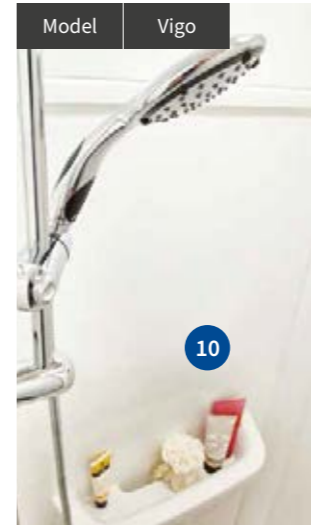

Model Vigo



Model Cabrera



- 1 **New** Belfast style washroom hand basin with swan neck tap and full decorative splashback
- 2 **New** front corner wall-mounted soft touch storage pouches
- 3 Soft close kitchen drawers with cutlery tray
- 4 Alde touch screen user-friendly control panel with back up battery for uninterrupted programming
- 5 **New** branded Perspex kitchen splashback with chrome detailing
- 6 Freestanding table with dedicated storage
- 7 **New** optional 'Temple' soft furnishings (cost option)

- 8 **New** Dometic 10-series 153 litre electronic fridge freezer with universal handed door mechanism (model specific)
- 9 Up to four USB sockets in directional spotlights and **New** wall mounted sockets
- 10 **New** in-shower moulded storage

- 11 **New** pre-wired for WiFi (Retailer fit)
- 12 **New** 'Silver' 15" (single axle models) or 14" (twin axle models) TUV tested alloy wheels

**Find your Retailer**  
Go to [baileyofofbristol.co.uk/find-a-retailer](http://baileyofofbristol.co.uk/find-a-retailer)

# Specification



## Exclusive Unicorn features

- **New** 'Silver' 15" (single axle models) or 14" (twin-axle models) TUV tested alloy wheels
- **New** vertical front infinity window and moulded surround with integral task lighting and speakers
- **New** 'Unicorn Series 5' graphics scheme
- **New** offside exterior service light
- **New** Bailey 'Light Oak' furniture finish
- **New** dual finish 'Satin Cashmere' British design overhead curved locker doors with 'Light Oak' contrasting stripe
- **New** streamline front corner lockers
- **New** conventional sprung cushion construction with knee roll base cushions and back rests, featuring premium quality fabrics
- **New** standard 'Chiswick' soft furnishings with co-ordinating curtain panels, two bolster cushions, two large square and two rectangular scatter cushions
- **New** optional 'Temple' soft furnishings with co-ordinating curtain panels, two bolster cushions, two large square and two rectangular scatter cushions
- **New** front corner wall-mounted soft touch storage pouches
- **New** 'Hazelnut' loose fit drop in carpets
- **New** pre-wired for WiFi (Retailer fit)
- **New** full width soft touch fixed bed headboards (model specific)
- **New** fold-out pull-up bunk (model specific)
- **New** dual shaped wardrobes to maximise fixed bed size, including mattress height storage cubby holes (model specific)
- **New** wider fixed double beds with aluminium frames and gas strut assisted opening mechanism (model specific)
- **New** branded Perspex kitchen splashback with chrome detailing
- **New** 'Nebula Silver' finish kitchen worktop laminate
- **New** built-in kitchen wine rack (model specific)
- **New** 'Cashmere' finish washroom worktop laminate
- **New** Belfast style washroom hand basin with swan neck tap and full decorative splashback
- **New** in-shower moulded storage
- **New** backlit washroom mirror (model specific)
- **New** high security exterior door lock

## Exterior features

- High performance GRP skinned 'Polar White' Alu-Tech bodyshell (Go to page 4 to find out more about our patented construction)
- AL-KO one-piece galvanised steel chassis, braking system and running gear
- **New** aerodynamic front profile
- **New** flush-fit single piece front impact resistant bumper with integral chrome capped grab handles and step up A-Frame fairing
- **New** flush-fit single piece rear impact resistant bumper with integral light cluster
- **New** rear vertical pillar mouldings with integral chrome capped grab handles
- Front corner steadies and heavy duty rear corner steadies
- **New** two-part pleated blind to vertical infinity window
- Double glazed polyplastic principal windows with Remis pleated flyscreen and blinds
- Midi and mini Heki rooflights located throughout the habitation area
- Hartal GRP skin two-part large aperture exterior door with window, waste bin and dustpan and brush, Hartal pleated full length flyscreen and exterior door drip tray
- **New** easy access exterior through-boot (model specific)
- Easy access exterior storage lockers

## Living room

- Premium quality chrome finish fixture and fittings
- 'Light Oak' finish freestanding table with dedicated storage
- 'Nebula Silver' wall mounted table (model specific)
- Two-drawer front chest with slide out occasional table and soft close drawers
- Beech slat seat bases with sprung hinged tops for extra comfort and ease of access

## Entertainment

- External satellite connection point
- Status 570 telescopic directional digital television aerial
- Up to two TV stations with 230v, 12v and two aerial sockets
- **New** up to two TV wall mounts (model specific)
- **New** branded DAB Radio with USB connection point and Bluetooth capability

## Bedroom

- Beech slat bed bases with sprung hinged tops for extra comfort and ease of access (model specific)
- **New** wider fixed single beds with aluminium frames (model specific)
- Superior foam fixed bed mattress construction (model specific)

## Kitchen features

- Drop down kitchen worktop extension (model specific)
- Drop down hob cover worktop in matching 'Nebula Silver' finish
- Stainless steel round kitchen sink with concealed fixings, swan-neck mixer tap, washing up bowl, drainer and chopping board
- Remis splash proof roller blind to kitchen window
- Soft close kitchen drawers with cutlery tray
- Dometic 101 litre refrigerator and 12 litre freezer with high security travel lock (model specific)
- Thetford 137 litre tower refrigerator with 15 litre freezer (model specific)
- Dometic 10-series 153 litre electronic fridge freezer with universal handed door mechanism and high security travel lock (twin axle models only)
- Thetford 'K-Series' combined oven, grill and hob with electronic ignition and flame failure device
- Thetford duel fuel hob with electronic hot plate and three gas burners
- **New** 700 watt Dometic microwave oven with non-moving ceramic hot plate

## Bathroom features

- Large white fully lined square shower cubicle with bi-fold partition door and integral lighting
- Ceiling mounted pull down hanging rail on shower hood
- Built in Thetford C-260 cassette toilet with remote header tank and recessed toilet roll storage shelf (model specific)

## Electrical

- **New** offside 230v power inlet for mains hook-up with Whale Easi-Slide cover
- Truma 80 watt solar panel
- **New** exterior 230v socket with integrated aerial jack outlet and Whale Easi-Slide cover
- 12v internal lighting system including LED down-lighters and directional spotlights plus ambient over locker and mid-level feature lighting
- **New** curtain track lighting
- 230v power supply with up to six interior sockets
- Up to four USB sockets in directional spotlights and **New** wall mounted sockets
- **New** centrally located electrical control panel

## Heating and plumbing

- Alde Hydronic Compact 3020 programmable radiator heating system with combined water heating
  - Alde 3020 boiler for improved fuel economy
  - Dual fuel 6.4kw gas and up to 3.15kw electric power sources
  - Alde touch screen user-friendly control panel with back up battery for uninterrupted programming
  - Washroom panel radiator
- On-board 40 litre water tank (twin axle models only)
- Whale high flow submersible pump
- Truma gas BBQ point

## Safety and security

- AL-KO ATC trailer control system
- AL-KO AKS 3004 stabiliser
- AL-KO shock absorbers
- AL-KO chassis mounted spare wheel carrier and steel spare wheel
- AL-KO caravan jack
- AL-KO secure portable wheel lock (two for twin axle models)

- TRACKER Monitor Thatcham CAT 7 approved Stolen Vehicle Recovery System (including first three months subscription fee)
- TRACKER PIR activated intruder alarm featuring a tilt sensor and key fob operation

## Warranty

- Supplied with a six-year transferable bodyshell integrity warranty and a three-year transferable manufacturer's warranty\*
- Four-year transferable extension to bodyshell integrity warranty (making ten years in total) and/or three-year transferable extension to manufacturer's warranty (making six years in total) available as cost options\*

## Optional extras

- **New** optional 'Temple' soft furnishings
- Bespoke caravan bedding sets to co-ordinate with caravan soft furnishings (model specific)

\*Terms and conditions apply. Please visit [baileyofofbristol.co.uk/warranties-servicing](http://baileyofofbristol.co.uk/warranties-servicing) for more information.



For a full list of specifications

Go to [baileyofofbristol.co.uk/unicorn](http://baileyofofbristol.co.uk/unicorn)



**Seville** 2 ↑

Internal Length	5.214m/17'1"
Shipping Length	6.474m/21'3"
Overall Width	2.264m/7'5"
Overall Height	2.669m/8'9"
Internal Headroom	1.960m/6'5"
Awning Size	944cm
Tyre Sizes	195/70R15C
MTPLM	1415kg
MRO	1289kg
Total User Payload	126kg

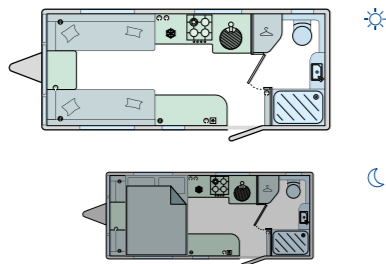

**Bed Sizes**

Front Double	1.93m x 1.52m/6'4" x 4'11"
Front N/S Single	1.95m x 0.63m/6'5" x 2'1"
Front O/S Single	1.95m x 0.63m/6'5" x 2'1"



**Madrid** 4 ↑

Internal Length	5.667m/18'7"
Shipping Length	6.881m/22'7"
Overall Width	2.264m/7'5"
Overall Height	2.669m/8'9"
Internal Headroom	1.960m/6'5"
Awning Size	1003cm
Tyre Sizes	195/70R15C
MTPLM	1500kg
MRO	1348kg
Total User Payload	152kg

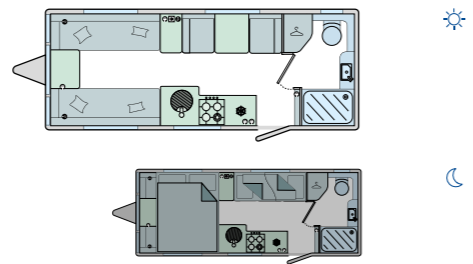

**Bed Sizes**

Front Double	1.93m x 1.52m/6'4" x 4'11"
Front N/S Single	1.95m x 0.63m/6'5" x 2'1"
Front O/S Single	1.95m x 0.63m/6'5" x 2'1"
Rear O/S Single	1.83m x 0.64m/6'0" x 2'1"
Rear O/S Fold-out Bunk	1.79m x 0.60m/5'10" x 1'11"



**Cadiz** 4 ↑

Internal Length	6.067m/19'11"
Shipping Length	7.340m/24'1"
Overall Width	2.264m/7'5"
Overall Height	2.669m/8'9"
Internal Headroom	1.960m/6'5"
Awning Size	1023cm
Tyre Sizes	195/70R15C
MTPLM	1600kg
MRO	1423kg
Total User Payload	177kg

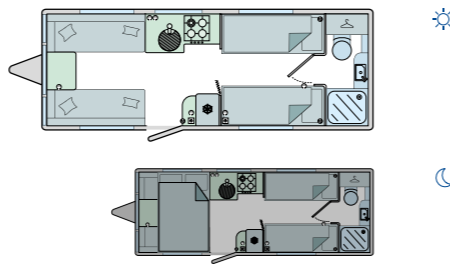

**Bed Sizes**

Front Double	1.93m x 1.31m/6'4" x 4'3"
Front N/S Single	1.75m x 0.63m/5'9" x 2'1"
Front O/S Single	1.75m x 0.63m/5'9" x 2'1"
Rear N/S Fixed Single	1.95m x 0.74m/6'4" x 2'5"
Rear O/S Fixed Single	1.95m x 0.74m/6'4" x 2'5"



**Vigo** 4 ↑

Internal Length	6.067m/19'11"
Shipping Length	7.340m/24'1"
Overall Width	2.264m/7'5"
Overall Height	2.669m/8'9"
Internal Headroom	1.960m/6'5"
Awning Size	1023cm
Tyre Sizes	195/70R15C
MTPLM	1600kg
MRO	1430kg
Total User Payload	170kg

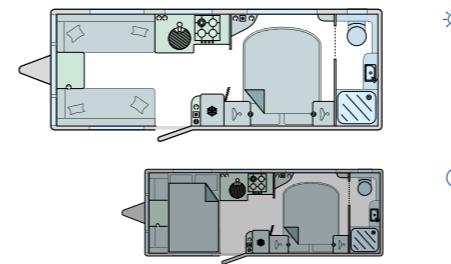

**Bed Sizes**

Front Double	1.93m x 1.31m/6'4" x 4'3"
Front N/S Single	1.75m x 0.63m/5'9" x 2'1"
Front O/S Single	1.75m x 0.63m/5'9" x 2'1"
Rear Fixed Double	1.90m x 1.44m/6'3" x 4'9"



**Cabrera** 4 ↑

Internal Length	6.067m/19'11"
Shipping Length	7.340m/24'1"
Overall Width	2.264m/7'5"
Overall Height	2.669m/8'9"
Internal Headroom	1.960m/6'5"
Awning Size	1023cm
Tyre Sizes	195/70R15C
MTPLM	1600kg
MRO	1439kg
Total User Payload	161kg

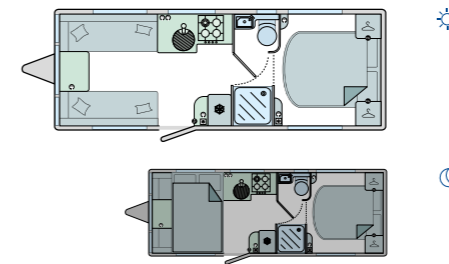

**Bed Sizes**

Front Double	1.93m x 1.31m/6'4" x 4'3"
Front N/S Single	1.75m x 0.63m/5'9" x 2'1"
Front O/S Single	1.75m x 0.63m/5'9" x 2'1"
Rear Fixed Double	1.90m x 1.44m/6'3" x 4'9"



**Cartagena** 4 ↑

Twin Axle

Internal Length	6.379m/20'11"
Shipping Length	7.815m/25'8"
Overall Width	2.264m/7'5"
Overall Height	2.669m/8'9"
Internal Headroom	1.960m/6'5"
Awning Size	1076cm
Tyre Sizes	185/65R14
MTPLM	1725kg
MRO	1566kg
Total User Payload	159kg

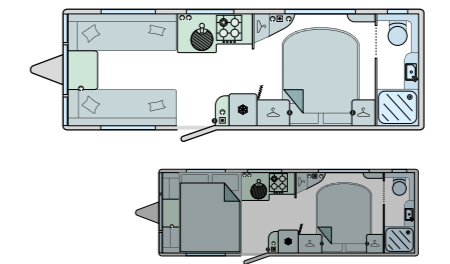

**Bed Sizes**

Front Double	1.93m x 1.52m/6'4" x 4'11"
Front N/S Single	1.95m x 0.63m/6'5" x 2'1"
Front O/S Single	1.95m x 0.63m/6'5" x 2'1"
Rear Fixed Double	1.90m x 1.44m/6'3" x 4'9"



**Pamplona** 4 ↑

Twin Axle

Internal Length	6.379m/20'11"
Shipping Length	7.815m/25'8"
Overall Width	2.264m/7'5"
Overall Height	2.669m/8'9"
Internal Headroom	1.960m/6'5"
Awning Size	1076cm
Tyre Sizes	185/65R14
MTPLM	1755kg
MRO	1596kg
Total User Payload	159kg

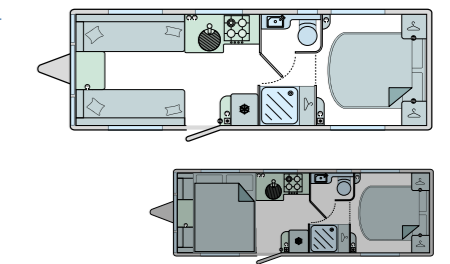

**Bed Sizes**

Front Double	1.93m x 1.52m/6'4" x 4'11"
Front N/S Single	1.95m x 0.63m/6'5" x 2'1"
Front O/S Single	1.95m x 0.63m/6'5" x 2'1"
Rear Fixed Double	1.90m x 1.44m/6'3" x 4'9"

A tolerance in the MRO has been allowed for in the calculations of Payload Margins. The awning length measurement shown is to be interpreted as a guide only and an enquiry should be made to individual awning manufacturers as to the correct size. Bed sizes are measured at the widest point of the bed.



Comfortable & capable

COMFY IN ALL  
THE RIGHT  
PLACES



#### Favourite facts

- Spacious yet lightweight design accessible to a wide range of tow vehicles
- AL-KO stabiliser hitch and TUV tested alloy wheels for added stability
- 700 watt Dometic microwave oven with non-moving ceramic hot plate
- Light and airy interiors featuring a vertical opening front skylight
- Thoughtful selection of 230v power sockets and USB points
- Four-season all weather sustainability with Truma Combi blown air heating system

6 Models

2-5 Berths

#### Get to know Phoenix+

Strike the perfect balance between space, comfort and affordability with the Phoenix+ range. Lightweight, versatile – and ready for everything.

Phoenix+ now has a six-strong range, so there's plenty of choice to meet your needs – and it makes joining the Bailey family more accessible than ever.

With a new look, inside and out, Phoenix+ is spacious, comfortable and well-equipped with practical design features and a touch of luxury, all in a robust and lightweight four-season package. Wherever you choose to make your holiday, Phoenix+ is the perfect base – anywhere and everywhere.

### Key features

- 1 New ambient lighting in front corners
- 2 Vertical front skylight
- 3 New 'Chesham' soft furnishings with co-ordinating curtains and two scatter cushions
- 4 New Bailey 'Light Oak' furniture finish
- 5 Two-drawer front chest with slide out occasional table and soft close drawers
- 6 New low level storage cupboard beneath front chest



- 7 Conventional cushion construction with fully sprung knee rolled base cushions and square back rests
- 8 New dual finish Italian design overhead curved locker doors with 'canvas' textured contrasting stripe and over-locker LED lighting
- 9 Bespoke caravan bedding sets to co-ordinate with caravan soft furnishings (cost option)

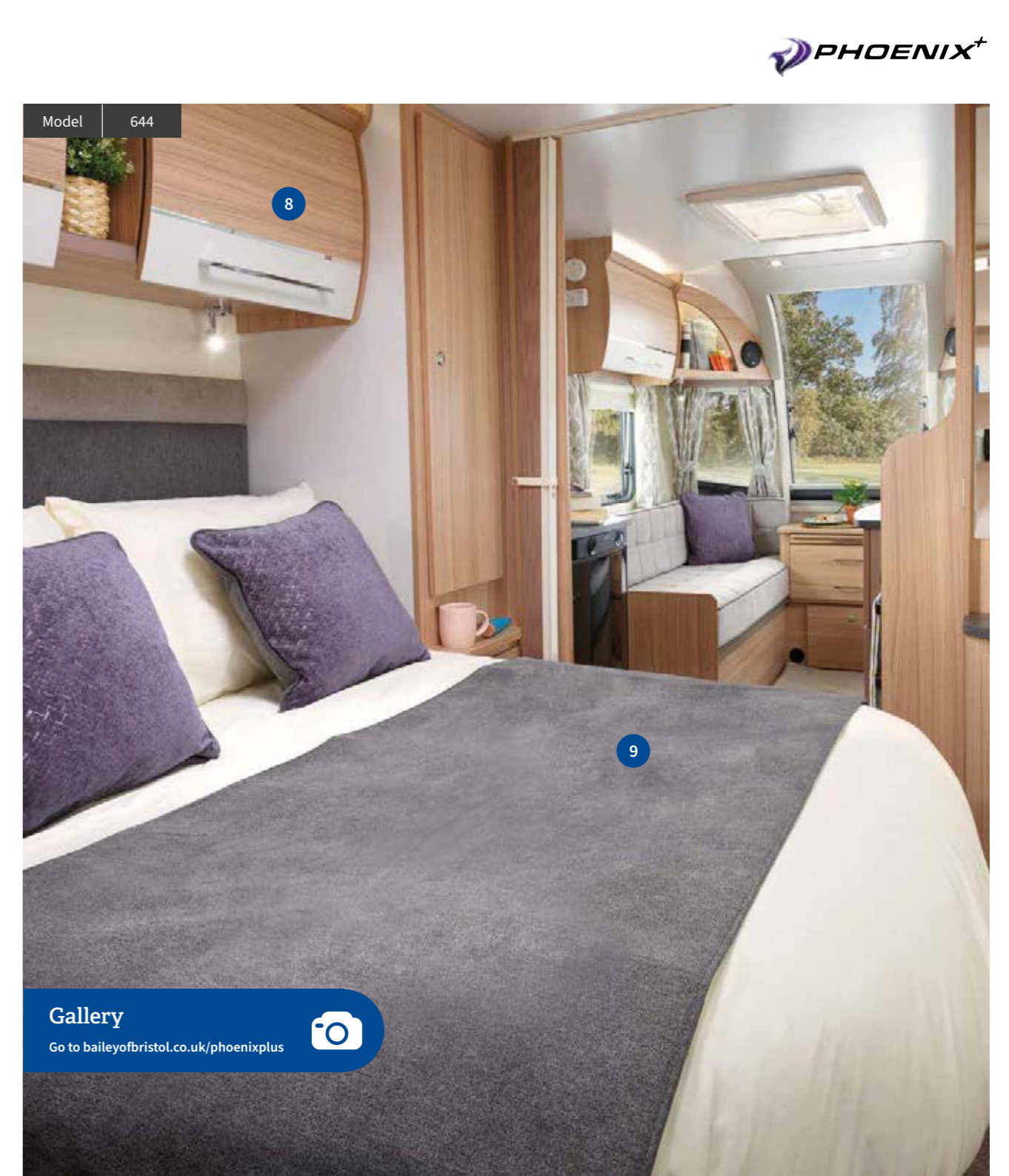

**Gallery**  
Go to [baileyofofbristol.co.uk/phoenixplus](http://baileyofofbristol.co.uk/phoenixplus)

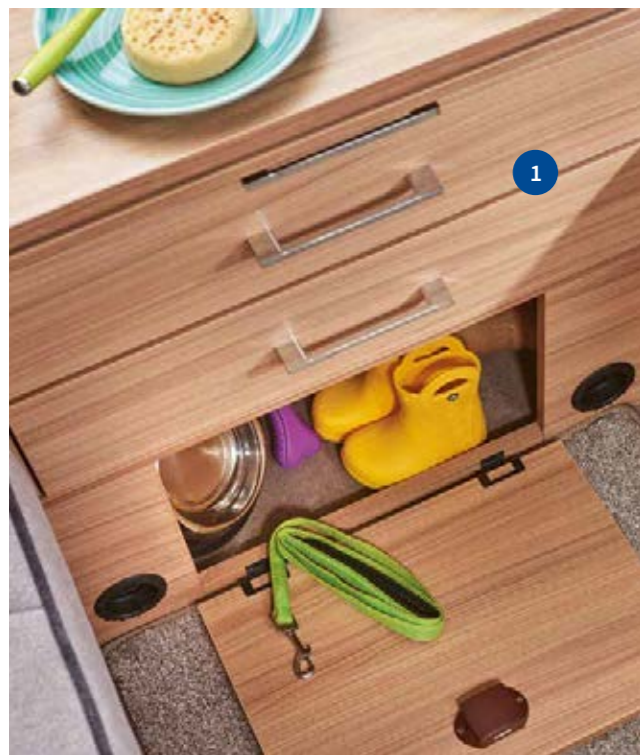

1

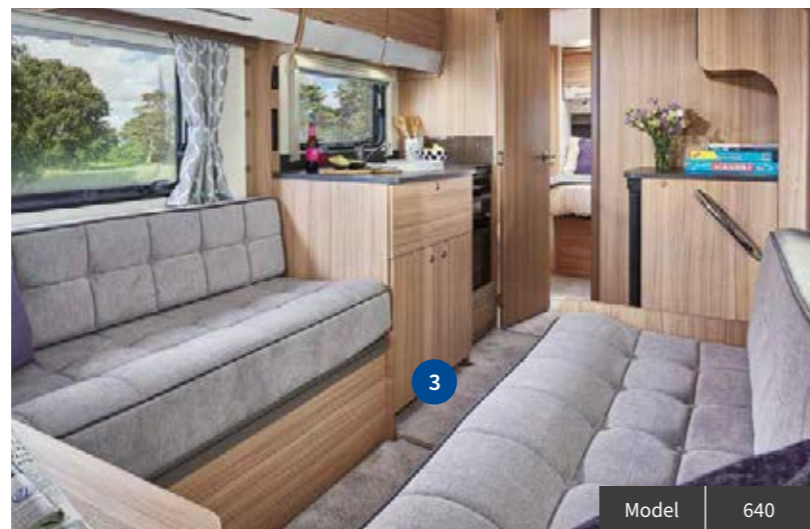

3

Model 640

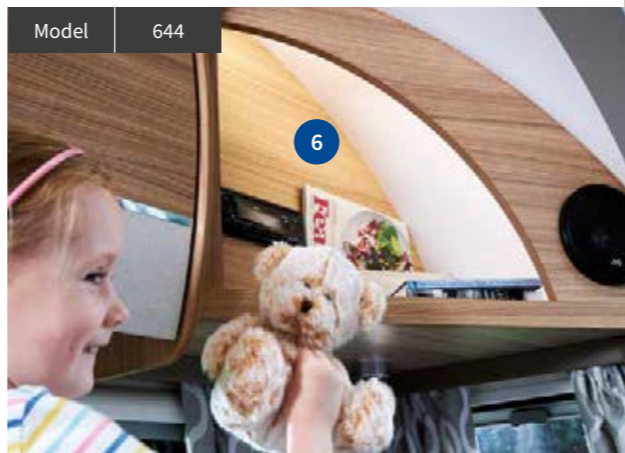

6

Model 644

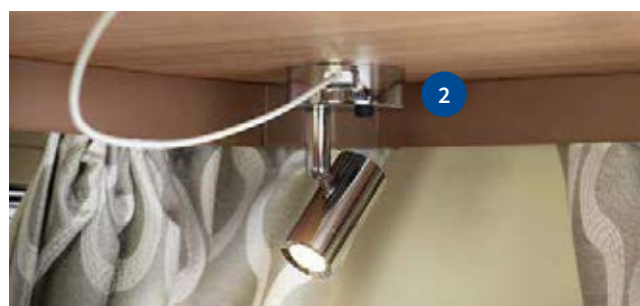

2

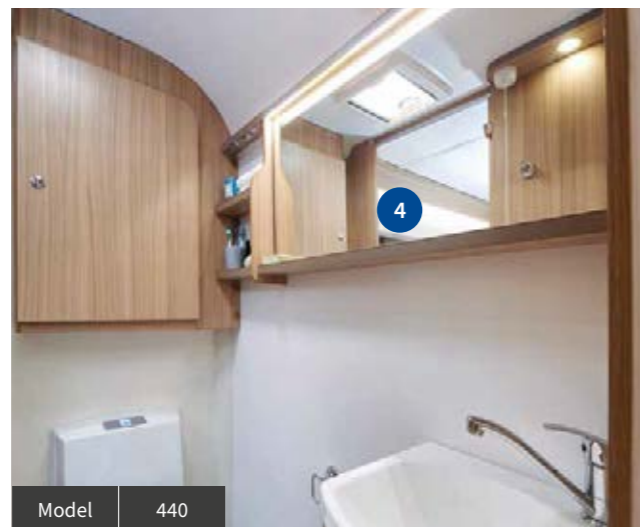

4

Model 440

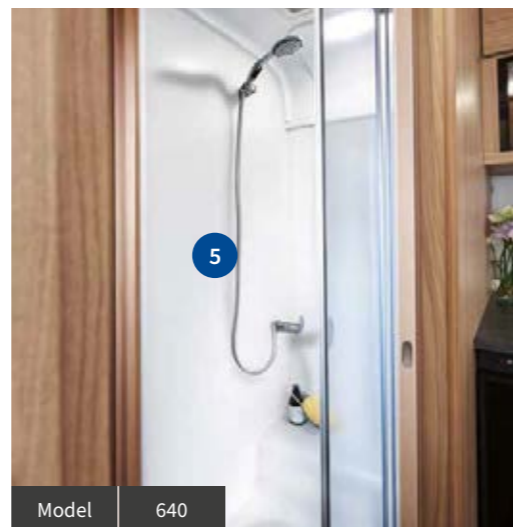

5

Model 640



7

8

9

10

11

Model 644



12

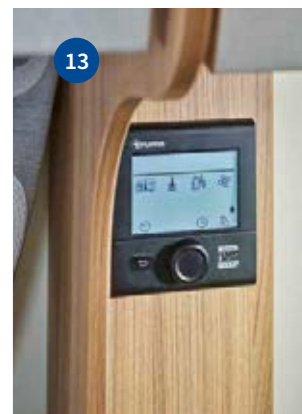

13



14

15

16

Find your Retailer  
Go to [baileيوفbristol.co.uk/find-a-retailer](http://baileيوفbristol.co.uk/find-a-retailer)

- 1 Additional hidden storage cabinet in front table
- 2 USB sockets in directional spotlights

- 3 New 'Hazelnut' loose fit drop in carpets
- 4 Full width washroom mirror (model specific)

- 5 White gloss shower cubicle with bi-fold partition door and integral lighting
- 6 New branded DAB radio with USB connection point and Bluetooth capability

- 7 New kitchen plate rack
- 8 New stainless steel round kitchen sink with concealed fixings, mixer tap and drainer

- 9 New wall mounted kitchen worktop upstand
- 10 Drop down hob cover worktop

- 11 Thetford hob with four gas burners
- 12 New 700 watt Dometic microwave oven with non-moving ceramic hot plate

- 13 Truma user-friendly digital control panel with adjustable fan and water boost functions
- 14 New 'Dove Grey' and 'Polar White' Alu-Tech Bodyshell

- 15 New 'Phoenix+' graphics scheme
- 16 New design 'Silver' finish 14" TUV tested alloy wheels

# Specification



## Exclusive Phoenix+ features

- **New** high performance GRP skinned 'Dove Grey' and 'Polar White' Alu-Tech Bodyshell
- **New** 'Phoenix+' graphics scheme
- **New** design 'Silver' finish 14" TUV tested alloy wheels
- **New** Bailey 'Light Oak' furniture finish
- **New** dual finish Italian design overhead curved locker doors with 'canvas' textured contrasting stripe
- **New** ambient lighting in front corners
- **New** low level storage cupboard beneath front chest
- **New** stainless steel round kitchen sink with concealed fixings, mixer tap and drainer
- **New** kitchen plate rack and cutlery tray
- **New** 700 watt Dometic microwave oven with non-moving ceramic hot plate
- **New** wall mounted kitchen worktop upstand in 'Nordic stone' finish
- **New** standard 'Chesham' soft furnishings with co-ordinating curtains and two scatter cushions
- **New** 'Hazelnut' loose fit carpet including washroom carpet
- **New** branded DAB radio with USB connection point and Bluetooth capability

## Exterior features

- AL-KO one-piece galvanised steel chassis, braking system and running gear
- Flush-fit front and rear impact resistant bumper with integral grab handles and step up A-frame fairing
- Aerodynamically profiled double glazed Polyplastic opening vertical front skylight and windows throughout
- Vertical front skylight surround with integral task lighting
- Remis pleated flyscreen and blinds to vertical skylight and front windows
- Remis cassette flyscreen and blinds to principal windows
- Midi and mini Heki rooflights located throughout the habitation area
- Hartal GRP skin two part large aperture exterior door with coat hook and Hartal pleated full length flyscreen
- Easy access exterior storage locker

## Living room

- Premium quality, domestic style fixtures and fittings in polished chrome finish
- 'Nordic Stone' finish freestanding table with dedicated storage
- 2-drawer front chest with slide out occasional table and soft close drawers
- Beech slat seat bases with sprung hinged tops for extra comfort and ease of access
- Conventional cushion construction with fully sprung knee rolled base cushions and square back rests featuring premium quality fabrics
- Silver finish interior grab handle for ease of access in and out of the caravan

## Entertainment

- Status 570 telescopic directional digital television aerial
- Up to two TV stations with 230v, 12v and one aerial socket
- Branded dual cone stereo speakers for superior sound quality
- Pre-wired for WiFi (Retailer fit)

## Bedroom

- Beech slat bed bases with sprung hinged tops for extra comfort and ease of access
- Fixed double beds with aluminium frames and gas strut assisted opening mechanism (model specific)
- Superior foam fixed bed mattress construction (model specific)
- Padded headboards in fixed beds (model specific)

## Kitchen features

- 'Nordic Stone' kitchen worktop laminate
- Drop down hob cover worktop in matching 'Nordic Stone' finish
- Dometic 98 litre refrigerator and 12 litre freezer with electronic ignition
- Thetford 'K-Series' combined oven, grill and hob with electronic ignition and flame failure device
- Thetford hob with four gas burners

## Bathroom features

- 'Nordic Stone' washroom worktop laminate
- White gloss shower cubicle with bi-fold partition door and integral lighting
- Bathroom storage cupboard
- Full width washroom mirror (model specific)
- Washroom hand basin and mixer tap
- Thetford C-260 cassette toilet with integrated header tank (model specific)
- Built in Thetford C-260 cassette toilet with remote header tank (model specific)

## Electrical

- 12v internal lighting system including LED down-lighters and directional spotlights
- 230v power supply with up to five interior sockets
- Two USB sockets in directional spotlights

## Heating and plumbing

- Truma Combi 2 heating system, combined water and room heating with dual fuel 2kw gas and 1.8kw electric power sources
- Truma user friendly digital control panel with adjustable fan and water boost functions
- Dual fuel 2kw gas and 1.8kw electric power sources
- Whale high flow submersible pump

## Safety and security

- AL-KO AKS 3004 stabiliser
- WSL individually laser balanced wheels fitted with 'Security' tyres and anti-tamper WSL safety bolts
- Interior floor mounted wheel and tyre

## Warranty

- Supplied with a six-year transferable bodyshell integrity warranty and a three-year transferable manufacturer's warranty\*
- Four-year transferable extension to bodyshell integrity warranty (making ten years in total) and/or three-year transferable extension to manufacturer's warranty (making six years in total) available as cost options\*

## Optional extras

- AL-KO ATC trailer control system (factory fit)
- Bespoke caravan bedding sets to co-ordinate with caravan soft furnishings (model specific)

\*Terms and conditions apply. Please visit [baileyofofbristol.co.uk/warranties-servicing](http://baileyofofbristol.co.uk/warranties-servicing) for more information.

For a full list of specifications  
Go to [baileyofofbristol.co.uk/phoenixplus](http://baileyofofbristol.co.uk/phoenixplus)





420

2 ↑

Internal Length	4.032m/13'2"
Shipping Length	5.564m/18'3"
Overall Width	2.212m/7'3"
Overall Height	2.624m/8'7"
Internal Headroom	1.960m/6'5"
Awning Size	857cm
Tyre Sizes	195/70R14
MTPLM	1146kg
MRO	1029kg
Total User Payload	117kg

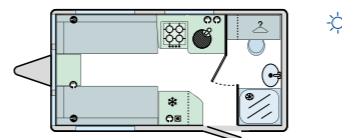

**Bed Sizes**

Front Double	1.88m x 1.47m/6'2" x 4'10"
Front N/S Single	1.88m x 0.64m/6'2" x 2'1"
Front O/S Single	1.88m x 0.64m/6'2" x 2'1"



440

4 ↑

Internal Length	5.351m/17'7"
Shipping Length	6.882m/22'7"
Overall Width	2.212m/7'3"
Overall Height	2.624m/8'7"
Internal Headroom	1.960m/6'5"
Awning Size	995cm
Tyre Sizes	185/R14C
MTPLM	1347kg
MRO	1197kg
Total User Payload	150kg

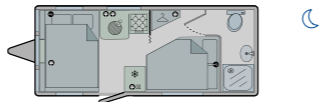
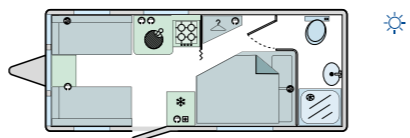

**Bed Sizes**

Front Double	1.88m x 1.10m/6'2" x 3'7"
Front N/S Single	1.50m x 0.64m/4'11" x 2'1"
Front O/S Single	1.50m x 0.64m/4'11" x 2'1"
Rear Fixed Double	1.90m x 1.32m/6'3" x 4'4"



642

4 ↑

Internal Length	5.841m/19'2"
Shipping Length	7.369m/24'2"
Overall Width	2.212m/7'3"
Overall Height	2.624m/8'7"
Internal Headroom	1.960m/6'5"
Awning Size	1035cm
Tyre Sizes	185/R14C
MTPLM	1410kg
MRO	1255kg
Total User Payload	155kg

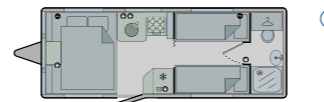
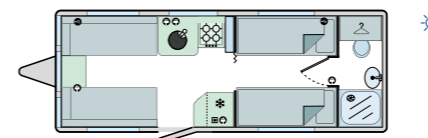

**Bed Sizes**

Front Double	1.88m x 1.40m/6'2" x 4'7"
Front N/S Single	1.81m x 0.64m/5'11" x 2'1"
Front O/S Single	1.81m x 0.64m/5'11" x 2'1"
Rear N/S Fixed Single	1.90m x 0.69m/6'3" x 2'3"
Rear O/S Fixed Single	1.90m x 0.69m/6'3" x 2'3"



644

4 ↑

Internal Length	5.841m/19'2"
Shipping Length	7.369m/24'2"
Overall Width	2.212m/7'3"
Overall Height	2.624m/8'7"
Internal Headroom	1.960m/6'5"
Awning Size	1035cm
Tyre Sizes	185/R14C
MTPLM	1395kg
MRO	1240kg
Total User Payload	155kg

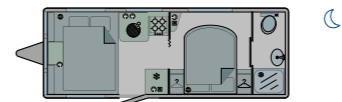
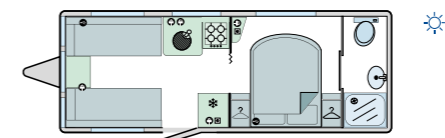

**Bed Sizes**

Front Double	1.88m x 1.40m/6'2" x 4'7"
Front N/S Single	1.81m x 0.64m/5'11" x 2'1"
Front O/S Single	1.81m x 0.64m/5'11" x 2'1"
Rear Fixed Double	1.89m x 1.39m/6'2" x 4'7"



640

4 ↑

Internal Length	5.841m/19'2"
Shipping Length	7.369m/24'2"
Overall Width	2.212m/7'3"
Overall Height	2.624m/8'7"
Internal Headroom	1.960m/6'5"
Awning Size	1035cm
Tyre Sizes	185/R14C
MTPLM	1411kg
MRO	1257kg
Total User Payload	155kg

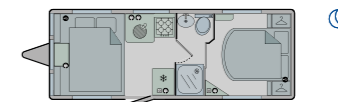
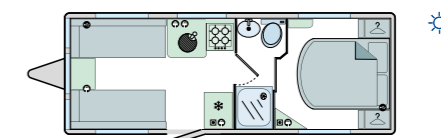

**Bed Sizes**

Front Double	1.88m x 1.40m/6'2" x 4'7"
Front N/S Single	1.81m x 0.64m/5'11" x 2'1"
Front O/S Single	1.81m x 0.64m/5'11" x 2'1"
Rear Fixed Double	1.89m x 1.39m/6'2" x 4'7"



650

5 ↑

Internal Length	5.841m/19'2"
Shipping Length	7.369m/24'2"
Overall Width	2.212m/7'3"
Overall Height	2.624m/8'7"
Internal Headroom	1.960m/6'5"
Awning Size	1035cm
Tyre Sizes	185/R14C
MTPLM	1409kg
MRO	1244kg
Total User Payload	165kg

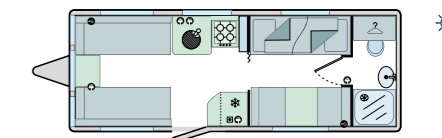

**Bed Sizes**

Front Double	1.88m x 1.40m/6'2" x 4'7"
Front N/S Single	1.81m x 0.64m/5'11" x 2'1"
Front O/S Single	1.81m x 0.64m/5'11" x 2'1"
Rear N/S Single	1.88m x 0.69m/6'2" x 2'3"
Rear O/S Fixed Bunks	1.86m x 0.66m/6'1" x 2'2"

A tolerance in the MRO has been allowed for in the calculations of Payload Margins. The awning length measurement shown is to be interpreted as a guide only and an enquiry should be made to individual awning manufacturers as to the correct size. Bed sizes are measured at the widest point of the bed.



Compact & confident

# DREAM BIG (THINK SMALL)



### Favourite facts

- Unique Alu-Tech wrap around bodyshell profile for improved aerodynamics
- AL-KO stabiliser hitch and TUV tested alloy wheels for added stability
- Four-season all weather sustainability with Truma Combi blown air heating system
- Light and airy interiors featuring a vertical opening front skylight
- Contemporary styling featuring contrasting furniture finishes
- Exclusive accessories including PRIMA wrap-around awning

### Get to know Discovery

Dare to be different, with the agile, eye-catching Discovery range. The contemporary styling and ingenious use of space make a Discovery the perfect partner to every adventure.

3 Models

2-4 Berths

Discovery takes adventuring to a whole new place. Its size means flexibility and get-up-and-go are built in: Discovery is ready to hit the road whenever you are.

Step inside and a compact exterior reveals a spacious interior. Across three models, contemporary styling blends seamlessly with practical design features, from innovative use of space and all-weather versatility, to premium fixtures and furnishings, and the Bailey signature vertical opening front skylight. And with a host of accessories to enhance Discovery even further, a new world of adventure awaits.



Model D4-2

### Key features

- 1 Opening vertical front skylight
- 2 'Lana Grey' matt overhead locker doors with contrast edging and over-locker LED lighting
- 3 'Java' soft furnishings with two square scatter cushions
- 4 Bespoke caravan bedding sets to co-ordinate with caravan soft furnishings (model specific)
- 5 Textured finish durable floor vinyl

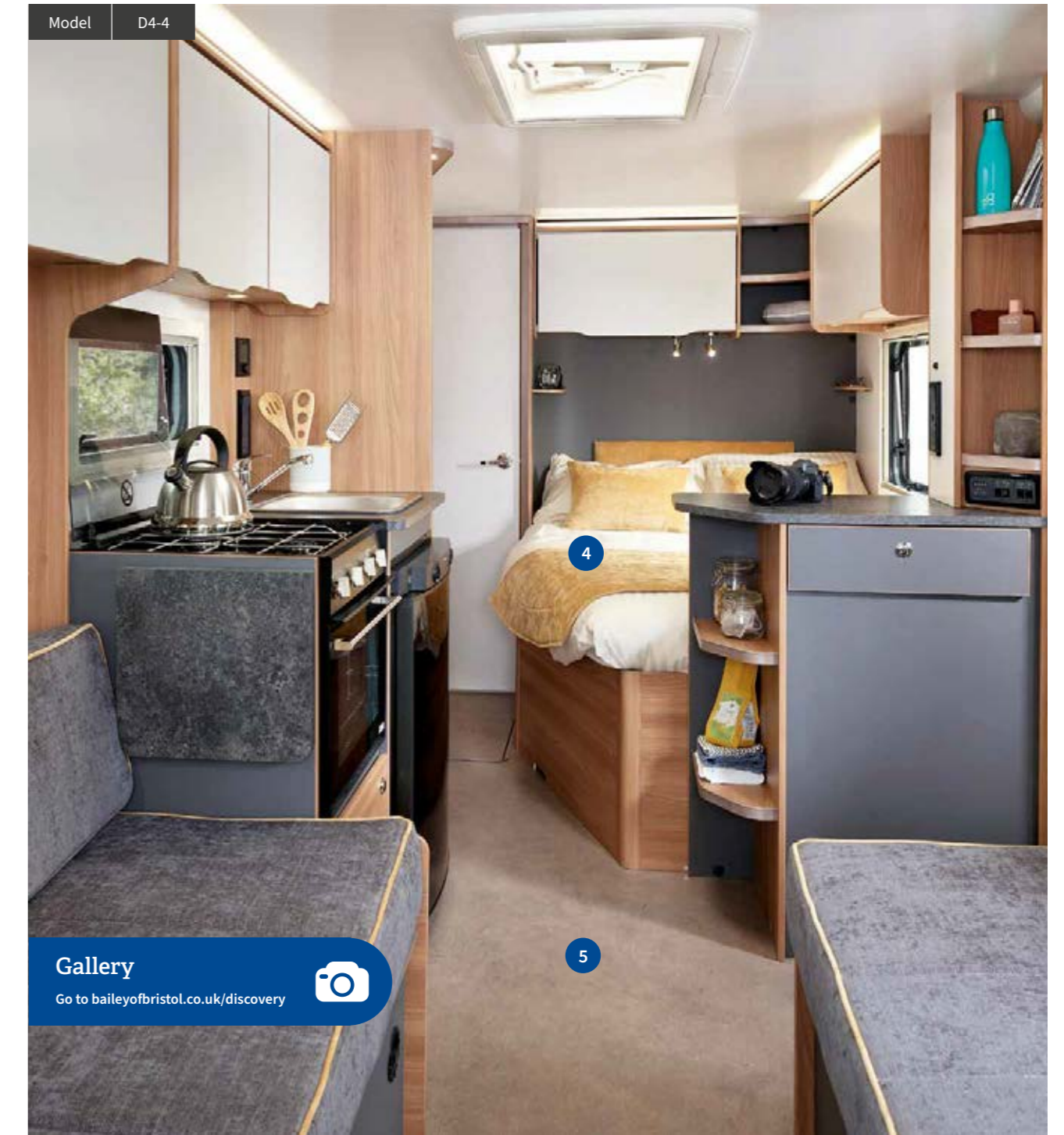

### Gallery

Go to [baileyofofbristol.co.uk/discovery](https://baileyofofbristol.co.uk/discovery)





1

Model D4-4

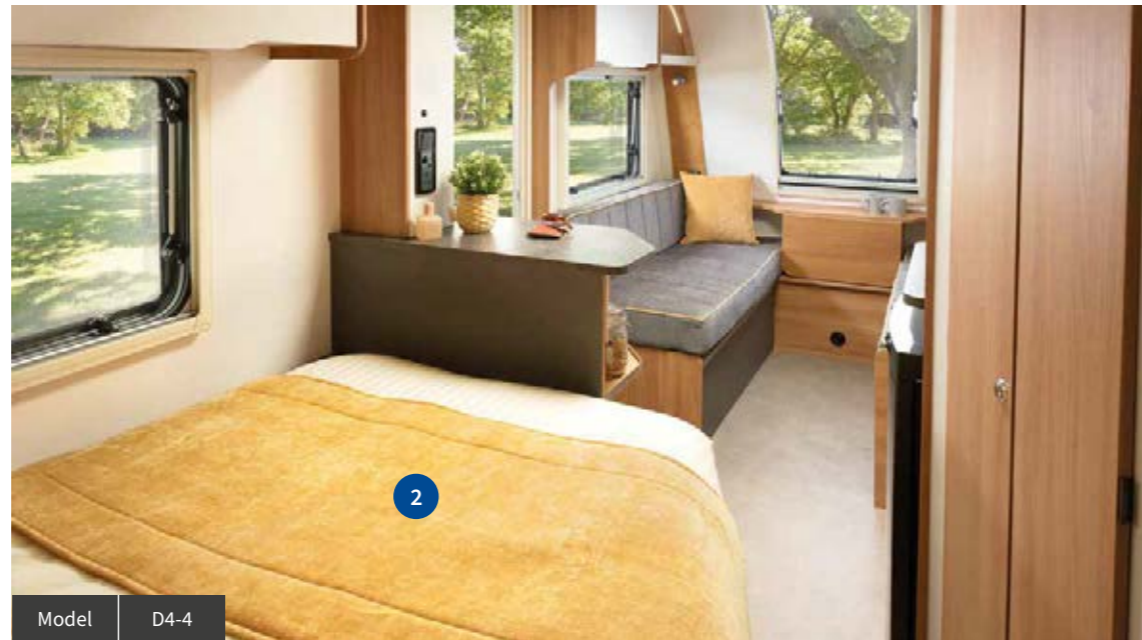

2

Model D4-4



Model D4-2



4

5

6

Model D4-3



7

Model D4-3

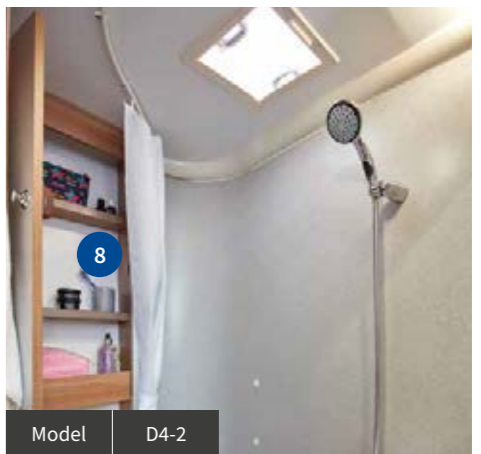

8

Model D4-2

- 1 'Granite Stone' fully lined shower cubicle with bi-fold partition shower door (model specific)
- 2 Superior foam fixed bed mattress construction

- 3 Drop down kitchen worktop extension
- 4 Stainless steel square kitchen sink with mixer tap
- 5 Thetford Triplex combination oven and grill with three gas burner hob
- 6 Dometic 103 litre refrigerator and 12 litre freezer
- 7 'Nordic Stone' finish wall-mounted rear lounge table (model specific)
- 8 Bathroom storage cupboard



1

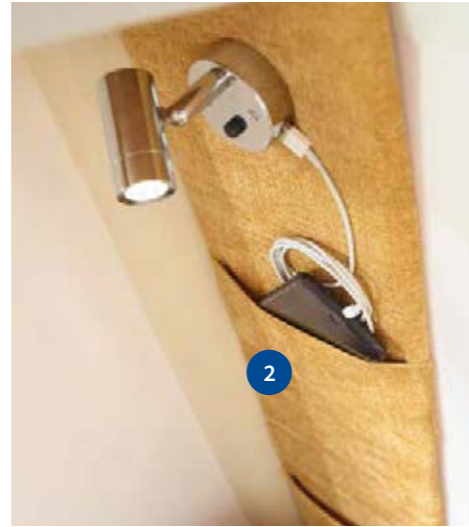

2



3

Model D4-3



4

Model D4-2



5



6

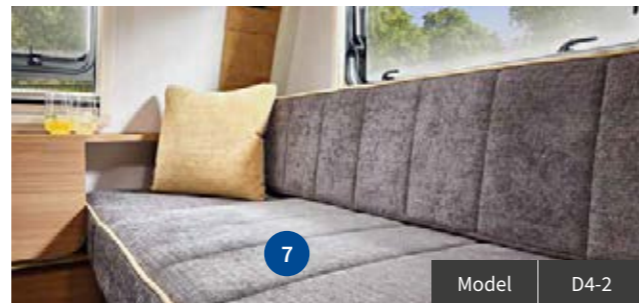

7

Model D4-2



Model D4-2



Model D4-4

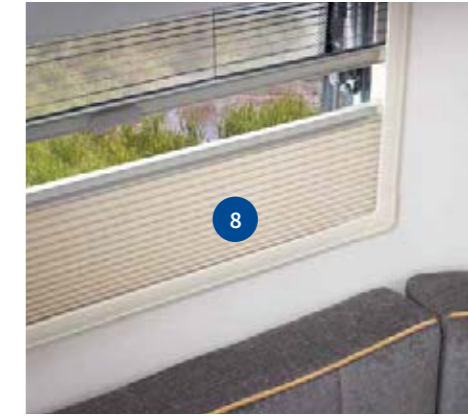

8



9

Model D4-2



10



11

- 1 Fold down occasional table
- 2 Front corner wall-mounted storage pouches
- 3 Wrap-around graphics scheme
- 4 Overhead locker with split level storage

- 5 Graphite finish 14" TUV tested alloy wheels
- 6 Ambient lighting in front corner
- 7 Sprung base cushions

- 8 Remis pleated flyscreen and blinds
- 9 Extended A-Frame suitable for additional optional storage solutions

- 10 Opening vertical front skylight
- 11 Truma user-friendly digital control panel with adjustable fan and water boost functions

**Find your Retailer**  
Go to [baileyofbristol.co.uk/find-a-retailer](http://baileyofbristol.co.uk/find-a-retailer)

# Specification



## Exterior features

- High performance GRP skinned duo-tone 'Polar White' and 'Dove Grey' Alu-Tech bodyshell (Go to page 4 to find out more about our patented construction)
- AL-KO one-piece galvanised steel chassis, braking system and running gear
- Flush fit front and rear impact resistant bumpers with grab handles
- Extended A-Frame suitable for additional optional storage solutions
- 'Graphite' finish 14" TUV tested alloy wheels
- Aerodynamically profiled double glazed Polyplastic opening vertical front skylight and windows throughout
- Remis two-part pleated flyscreen and blind to vertical skylight and Remis pleated flyscreen and blinds to principal windows
- Midi Heki roof light in main habitation area
- Hartal GRP skin two-part large aperture exterior door with coat hook and Hartal pleated full length flyscreen
- Easy access exterior storage lockers
- Wrap-around graphics scheme

## Living room

- Bailey 'Mendip Ash', 'Lana Grey' and 'Anthracite' furniture finishes
- 'Lana Grey' matt overhead locker doors with contrast edging and over-locker LED lighting
- Premium quality, domestic style fixtures and fittings in polished chrome finish
- 'Nordic Stone' finish freestanding table with dedicated storage
- 'Nordic Stone' finish wall mounted rear lounge table (model specific)
- Fold down occasional table
- Beech slat seat bases with sprung hinged tops for extra comfort and ease of access
- Upholstery featuring premium quality fabrics, sprung base cushions and foam back rests
- 'Java' soft furnishings with two square scatter cushions
- Front corner wall-mounted storage pouches

## Entertainment

- Status 570 telescopic directional digital television aerial
- One TV station with 230v, 12v and one aerial socket
- Pre-wired for WiFi (Retailer fit)

## Bedroom

- Beech slat bed bases with sprung hinged tops for extra comfort and ease of access (model specific)
- Fixed double beds with aluminium frames and gas strut assisted opening mechanism (model specific)
- Superior foam fixed bed mattress construction (model specific)

## Kitchen features

- 'Nordic Stone' kitchen worktop laminate
- Drop down kitchen worktop extension
- Stainless steel square kitchen sink with mixer tap
- Dometic 103 litre refrigerator and 12 litre freezer with electronic ignition
- Thetford Triplex combination oven and grill with three gas burner hob

## Bathroom features

- Roof light located in washroom
- 'Nordic Stone' washroom worktop laminate (model specific)
- 'Granite Stone' fully lined shower cubicle with bi-fold partition shower door (model specific)
- 'Granite Stone' fully lined shower wet room with partition curtain (model specific)
- Bathroom storage cupboard
- Washroom hand basin and mixer tap with integrated storage (model specific)
- Thetford C-260 cassette toilet with integrated header tank

## Electrical

- 12v internal lighting system including LED down-lighters and directional spotlights
- 230v power supply with up to four interior sockets
- Two USB sockets in directional spotlights

## Heating and plumbing

- Truma Combi 2 heating system, combined water and room heating with dual fuel 2kw gas and 1.8kw electric power sources
- Truma user-friendly digital control panel with adjustable fan and water boost functions
- Truma Ultraflow submersible pump

## Safety and security

- AL-KO AKS 3004 stabiliser
- WSL individually laser balanced wheels fitted with 'Security' tyres and anti-tamper WSL safety bolts
- Interior floor-mounted spare wheel and tyre (steel wheel)

## Warranty

- Supplied with a six-year transferable bodyshell integrity warranty and a three-year transferable manufacturer's components warranty\*
- Four-year transferable extension to bodyshell integrity warranty (making ten years in total) and/or three-year transferable extension to manufacturer's warranty (making six years in total) available as cost options\*

## Optional extras

- Bespoke caravan bedding sets to co-ordinate with caravan soft furnishings (model specific)

## Accessories

- Exclusive PRIMA storage box fitted to front A-Frame
- Thule bike rack fitted to front A-Frame
- 'Willow Grey' Split section loose fit drop in carpet

\*Terms and conditions apply. Please visit [baileyofbristol.co.uk/warranties-servicing](http://baileyofbristol.co.uk/warranties-servicing) for more information.

**For a full list of specifications**  
Go to [baileyofbristol.co.uk/discovery](http://baileyofbristol.co.uk/discovery)



**D4-2**      2↑

Internal Length	3.866m/12'8"
Shipping Length	5.615m/18'5"
Overall Width	2.228m/7'4"
Overall Height	2.605m/8'7"
Internal Headroom	1.960m/6'5"
Awning Size	1004cm
Tyre Sizes	185/R14C
MTPLM	995kg
MRO	884kg
Total User Payload	111kg

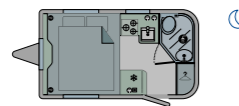
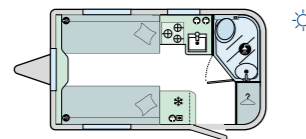

**Bed Sizes**

Front Double	1.88m x 1.72m/6'2" x 5'8"
Front N/S Single	2.00m x 0.64m/6'7" x 2'1"
Front O/S Single	2.00m x 0.64m/6'7" x 2'1"



**D4-3**      3↑

Internal Length	4.354m/14'3"
Shipping Length	6.112m/20'1"
Overall Width	2.228m/7'4"
Overall Height	2.605m/8'7"
Internal Headroom	1.960m/6'5"
Awning Size	1056cm
Tyre Sizes	185/R14C
MTPLM	1082kg
MRO	946kg
Total User Payload	136kg

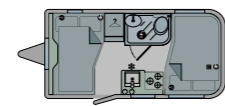
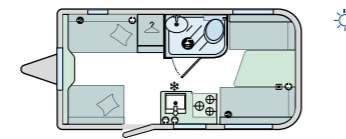

**Bed Sizes**

Front Single	1.88m x 0.92m/6'2" x 3'0"
Rear Double	1.98m x 1.22m/6'6" x 4'0"



**D4-4**      4↑

Internal Length	5.398m/17'9"
Shipping Length	7.141m/23'5"
Overall Width	2.228m/7'4"
Overall Height	2.605m/8'7"
Internal Headroom	1.960m/6'5"
Awning Size	1156cm
Tyre Sizes	185/R14C
MTPLM	1206kg
MRO	1059kg
Total User Payload	147kg



**Bed Sizes**

Front Double	1.88m x 1.37m/6'2" x 4'6"
Front N/S Single	1.65m x 0.64m/5'5" x 2'1"
Front O/S Single	1.65m x 0.64m/5'5" x 2'1"
Rear Fixed Double	1.86m x 1.32m/6'1" x 4'4"

A tolerance in the MRO has been allowed for in the calculations of Payload Margins. The awning length measurement shown is to be interpreted as a guide only and an enquiry should be made to individual awning manufacturers as to the correct size. Bed sizes are measured at the widest point of the bed.

Compare Discovery online    Go to [baileyofbristol.co.uk/compare-discovery](http://baileyofbristol.co.uk/compare-discovery)



**Even more Discovery**

Enhance your Discovery with a range of bespoke accessories. You can increase your storage options with an A-Frame mounted storage box, or a Thule bike rack, so you can get out and about when you're out and about.

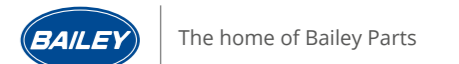

Discover more at [primaleisure.com](http://primaleisure.com)



The home of Bailey Parts

## Exceptional aftersales and accessories

Once you're the proud owner of a Bailey caravan, we want you to get the very best out of it. So, whether you're adding some finishing touches to really make it your own or tracking down a tricky-to-find part, the PRIMA team of caravanners, campers and outdoor enthusiasts is here to help – and proud to offer you exceptional aftersales service.

With over 25,000 products, the PRIMA online shop has everything you need. Search by vehicle make and model, and browse our expanded category range. In-stock items are dispatched with thousands of original parts available to order.

We look forward to helping you 'Go Bailey'.



**25,000+**  
Products available to browse

Shop 24 hours a day 7 days a week

Technical team available to help

Deliver directly to you while on holiday (UK only)

Genuine OEM parts and quality accessories

Discover more at [primaleisure.com](http://primaleisure.com)



## Where to buy your Bailey

The next step is to find out a little bit more. We have a network of approved Retailers across the country, who we choose to work with because of their expertise. And, like us, they love to get out there and Go Bailey! themselves.

Once you've found your Retailer, you can explore the ranges and models first-hand, along with pre-owned Bailey caravans,\* and find out which one is 'the one'. The Retailer will be on-hand to guide you through your decision and will be happy to talk through finance options, if you need them.

### The Bailey warranty

Your new Bailey comes with the peace of mind of our manufacturer's warranty. Your caravan's bodyshell is covered with a six-year integrity warranty, while other parts and components are covered for up to three years.\*\*

\*Subject to availability.  
\*\*Terms and conditions apply. Please refer to [baileyofbristol.co.uk](http://baileyofbristol.co.uk) for more details.



 Find your Retailer [Go to baileyofbristol.co.uk/find-a-retailer](http://Go to baileyofbristol.co.uk/find-a-retailer)

# JOIN THE CLUB



## Bailey Owners Club

Once you're out on the road with your Bailey, you're already part of an exclusive club. So why not go one step further and join the real thing?

The Bailey Owners Club is here to help you get the most from your Bailey caravan or motorhome. Completely independent from Bailey of Bristol, there are members all over the world – and there's even a 'Little Bees' club for younger caravanners.

Membership is full of benefits. You'll be invited to weekend events and rallies across the UK, often at exclusive venues, while enjoying discounts on longer holidays in the UK and abroad – as well as online discounts at PRIMA Leisure, of course. You'll even have the chance to come and tour the Bailey factory, and meet the people behind Bailey.

 Join the club  
[Go to baileyownersclub.org](http://Go to baileyownersclub.org)



Join our community



[baileyofbristol.co.uk](http://baileyofbristol.co.uk)



This brochure does not constitute an offer by Bailey Caravans Ltd (Bailey). Bailey reserves the right to alter specifications and prices as market and supply conditions demand. Your Bailey Retailer will confirm all specification details prior to you making your purchasing decision. E. & O. E. Bailey Retailers sell our products of their own choice and not as agents of Bailey. Accordingly they have no authority to bind Bailey or to make any representation or undertaking whatsoever on behalf of Bailey. All household items illustrated in this brochure are used to enhance photography and are for display purposes only. They are not supplied with your touring caravan. Photographic colour reproduction is subject to the limitations of the production process.  
Printed September 2022.

**Designed and produced by:** saintnicks

**Photography:** Alan Bond, assisted by Henry Howard.

**Photography locations:**

**Alicanto Grande:** Cheddar Mendip Heights Camping and Caravanning Club Site

[www.campingandcaravanningclub.co.uk](http://www.campingandcaravanningclub.co.uk)

**Pegasus Grande SE:** Southfield Farm CL, Malmesbury, Wiltshire [www.southfieldfarm.co.uk](http://www.southfieldfarm.co.uk)

**Unicorn:** Little Meadow Campsite, Watermouth, Ilfracombe, Devon [www.littlemeadow.co.uk](http://www.littlemeadow.co.uk)

**Phoenix+:** Leigh Court, Abbots Leigh, Bristol [www.leighcourt.co.uk](http://www.leighcourt.co.uk), and Clevedon Beach

**Discovery:** Back of Beyond Touring Park, Saint Leonards, East Dorset

[www.backofbeyondtouringpark.co.uk](http://www.backofbeyondtouringpark.co.uk)

## 8ft wide Touring Caravans

## Touring Caravans

Berth  
↑



2

**Seville** £29,599 | **MTPLM** 1415kg

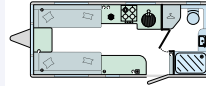

**420** £22,399 | **MTPLM** 1146kg

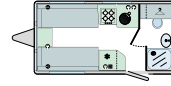

**D4-2** £19,999 | **MTPLM** 995kg

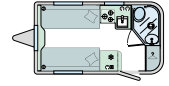

3

**D4-3** £20,899 | **MTPLM** 1082kg

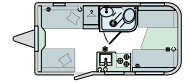

4  
Side dinette

**Madrid** £30,699 | **MTPLM** 1500kg



4  
Double corner bed

**440** £23,999 | **MTPLM** 1347kg

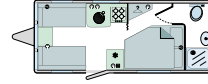

**D4-4** £21,499 | **MTPLM** 1206kg



4  
Island double bed

**Brindisi** £28,399 | **MTPLM** 1539kg

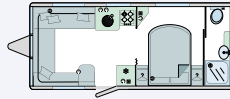

**Vigo** £31,399 | **MTPLM** 1600kg

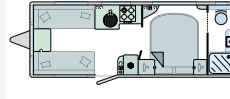

**644** £24,499 | **MTPLM** 1395kg

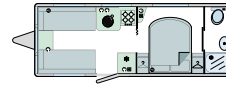

**Lisbon** £36,699 | **MTPLM** 1700kg

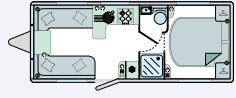

**Bologna** £30,999 | **MTPLM** 1656kg

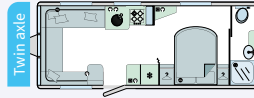

**Cartagena** £33,999 | **MTPLM** 1725kg

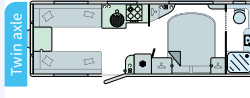

**Evora** £38,499 | **MTPLM** 1855kg

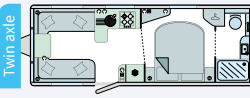

**Cabrera** £31,399 | **MTPLM** 1600kg

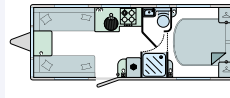

**640** £24,499 | **MTPLM** 1411kg

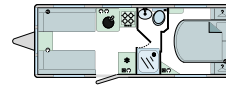

**Porto** £38,499 | **MTPLM** 1847kg

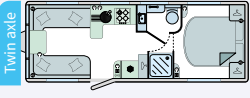

**Messina** £30,999 | **MTPLM** 1698kg

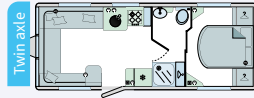

**Pamplona** £33,999 | **MTPLM** 1755kg

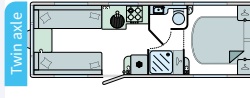

4  
Twin beds

**Rimini** £28,399 | **MTPLM** 1556kg

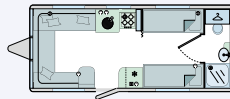

**Cadiz** £31,399 | **MTPLM** 1600kg

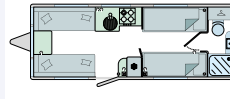

**642** £24,499 | **MTPLM** 1410kg

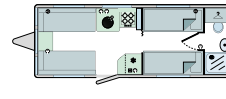

5

**Ancona** £29,399 | **MTPLM** 1600kg

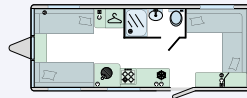

**650** £24,499 | **MTPLM** 1409kg

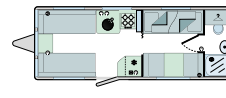

6

**Palermo** £30,999 | **MTPLM** 1715kg

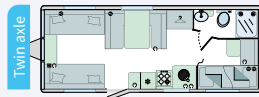

**Turin** £30,999 | **MTPLM** 1724kg



## 8ft wide Touring Caravans



Luxurious & limitless



Stylish & spacious

Lisbon	£36,699
Evora	£38,499
Porto	£38,499
'Latimer' alternative upholstery with Aquaclean	£225
Rimini	£28,399
Brindisi	£28,399
Ancona	£29,399
Bologna	£30,999
Messina	£30,999
Palermo	£30,999
Turin	£30,999
'Barbican' alternative upholstery	£225



Find your nearest Retailer Go to [baileyofbristol.co.uk/find-a-retailer](http://baileyofbristol.co.uk/find-a-retailer)

## Touring Caravans



Effortless & elegant

Seville	£29,599
Madrid	£30,699
Cadiz	£31,399
Vigo	£31,399
Cabrera	£31,399
Cartagena	£33,999
Pamplona	£33,999
'Temple' alternative upholstery	£225



Comfortable & capable

420	£22,399
440	£23,999
642	£24,499
644	£24,499
640	£24,499
650	£24,499
AL-KO ATC Trailer Control System (Retailer fitted option)	3.0kg From £514.99



Compact & confident

D4-2	£19,999
D4-3	£20,899
D4-4	£21,499
Discovery accessories available at <a href="http://primaleisure.com">primaleisure.com</a>	
Exclusive PRIMA storage box fitted to front A-Frame	24kg £620
Thule bike rack fitted to front A-Frame	9.7kg From £349
'Willow Grey' split section loose fit drop in carpets	4.55kg From £198.40

Optional extras available in all ranges

Bespoke caravan bedding sets to co-ordinate with caravan soft furnishings (model specific)	Up to 7.3kg	From £222
4-year extension to standard 6-year bodyshell integrity warranty (ten years in total)* inc IPT		£265
3-year extension to standard 3-year manufacturers warranty (six years in total)* inc IPT		£439

All prices shown include VAT at 20%. Please see below for important price information.

Price Guarantee. These prices are guaranteed subject to you ordering your caravan from the earliest production availability and that you take delivery within 14 days of dispatch from the factory. Retailer Delivery Charge. Your Bailey Retailer will make a charge of up to £645 to cover the cost of various additional services carried out prior to you taking possession of your new Bailey tourer. The main element of this charge will be the cost of transporting your tourer from the Bailey factory to your vending Retailer's premises. Your Bailey Retailer can confirm the details of the additional services available prior to making your choice. Optional Extras. Options pricing is only applicable on new leisure vehicle orders. Ask your supplying Retailer for more information. \*Terms and conditions apply to the warranty extension schemes.